

No	a x b	x	No	a x b	x
1	1600x448	1	16	318x540	2
2	1600x448	1	17	383x540	5
3	518x400	6	18	973x515	1
4	500x400	1	19	470x354	3
5	1888x448	1	20	920x380	1
6	1888x410	1	21		
7	1888x410	1	22		
8	1888x448	1	23		
9	1882x526	2	24		
10	323x494	1	25		
11	202x494	3	26		
12	443x100	3	27		
13	350x100	6	28		
14	927x500	1	29		
15	1275x540	1	30		

(ENG)

Hallway Angelina

(UA)

Передпокій Ангеліна

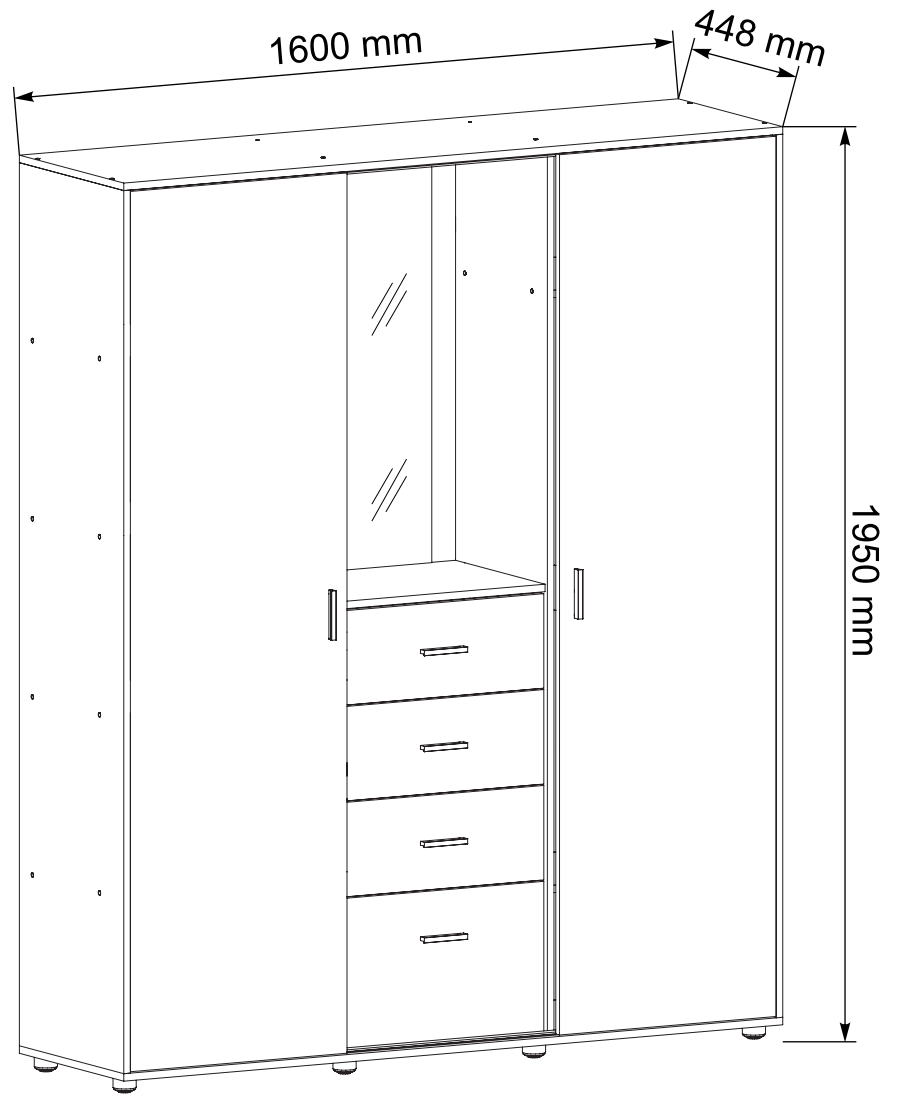

Hallway Angelina Передпокій Ангеліна

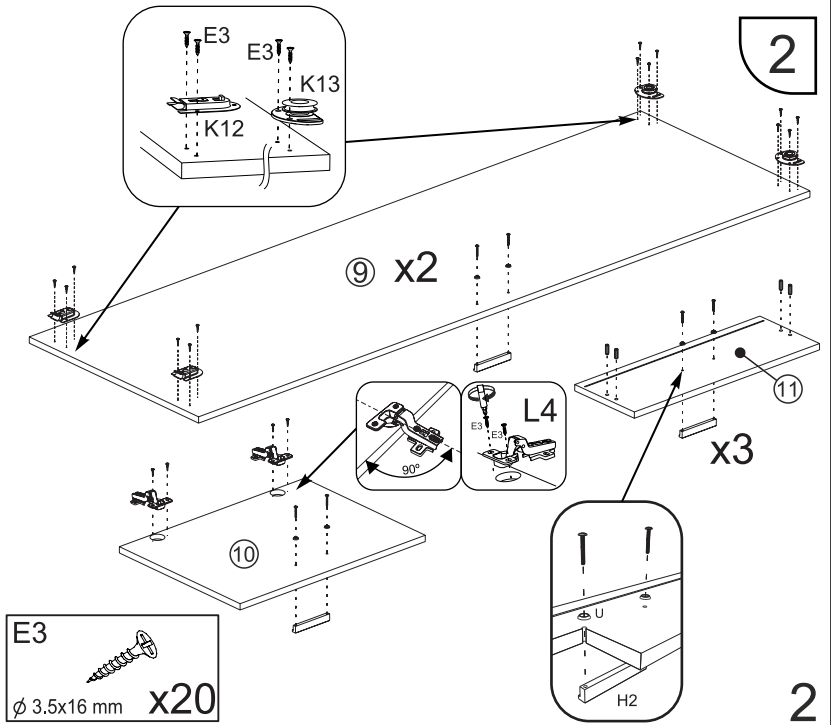
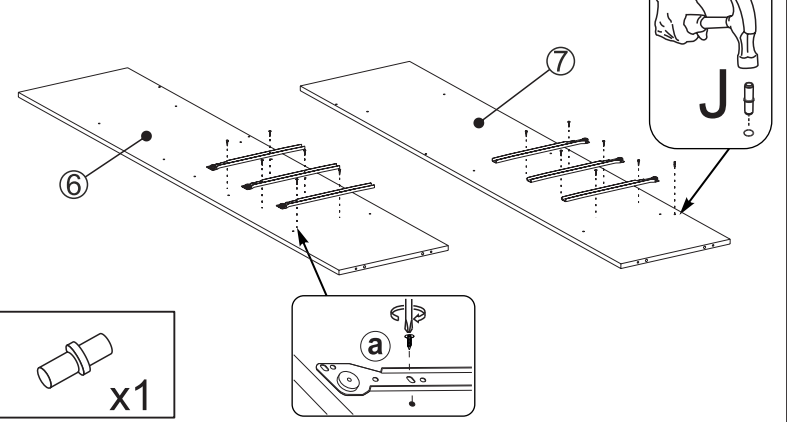
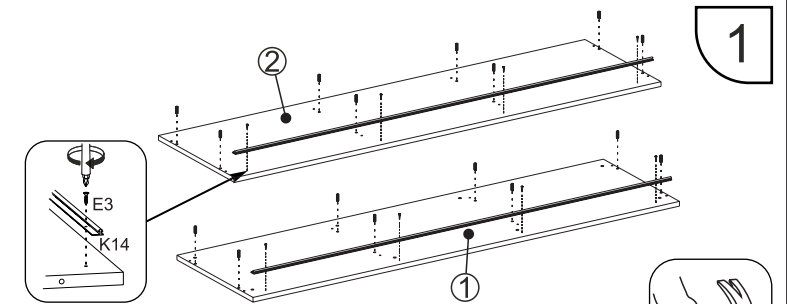
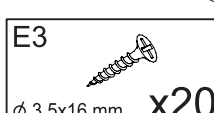
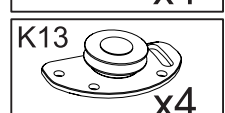
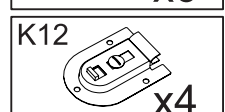
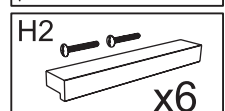
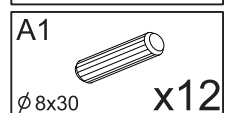
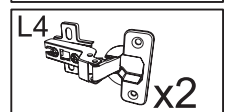
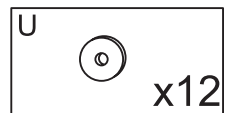
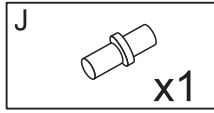
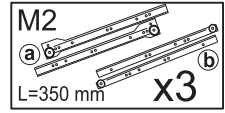
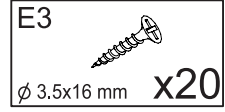
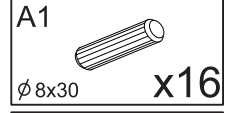
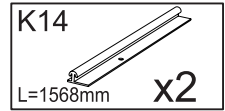
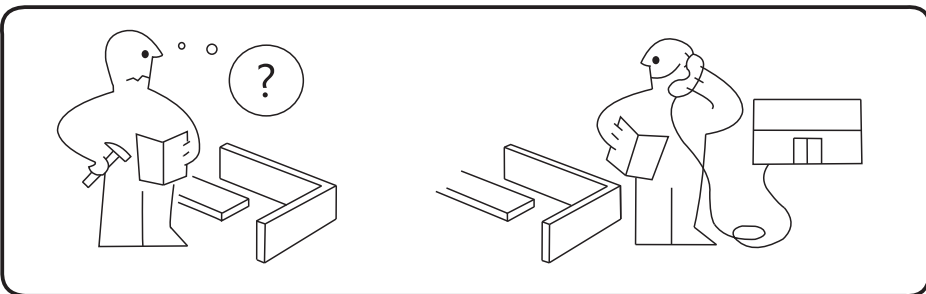
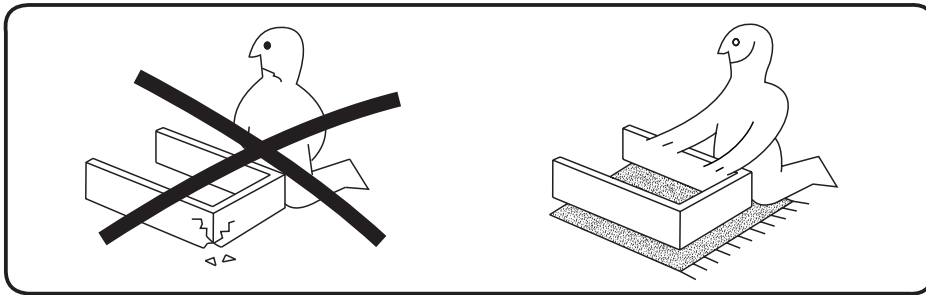
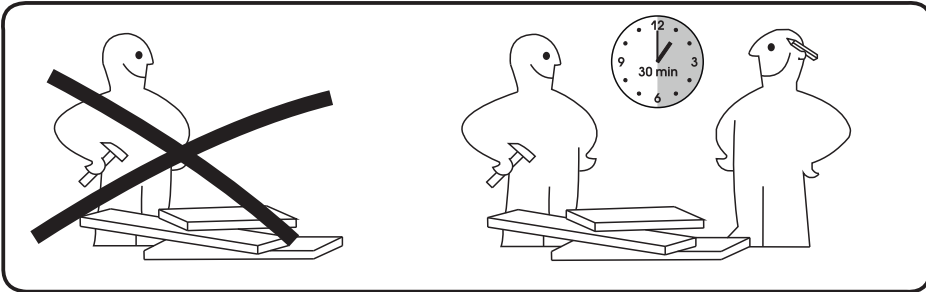
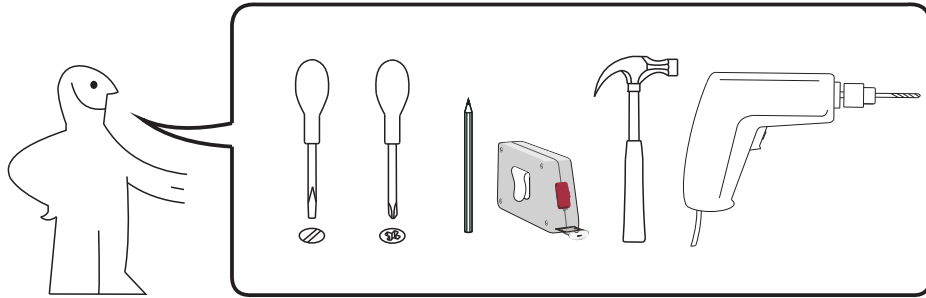

Hallway Angelina
Передпокій Ангеліна

3

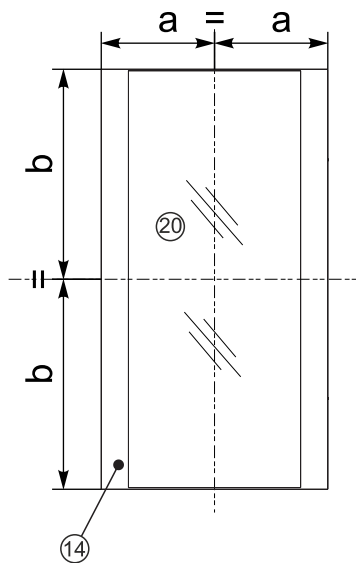
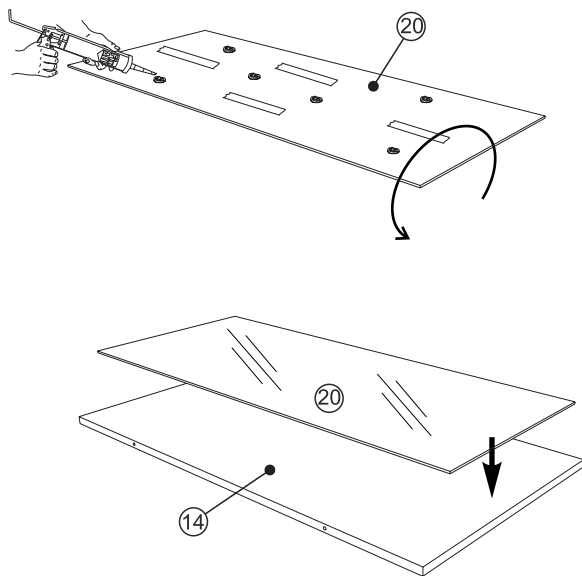

5

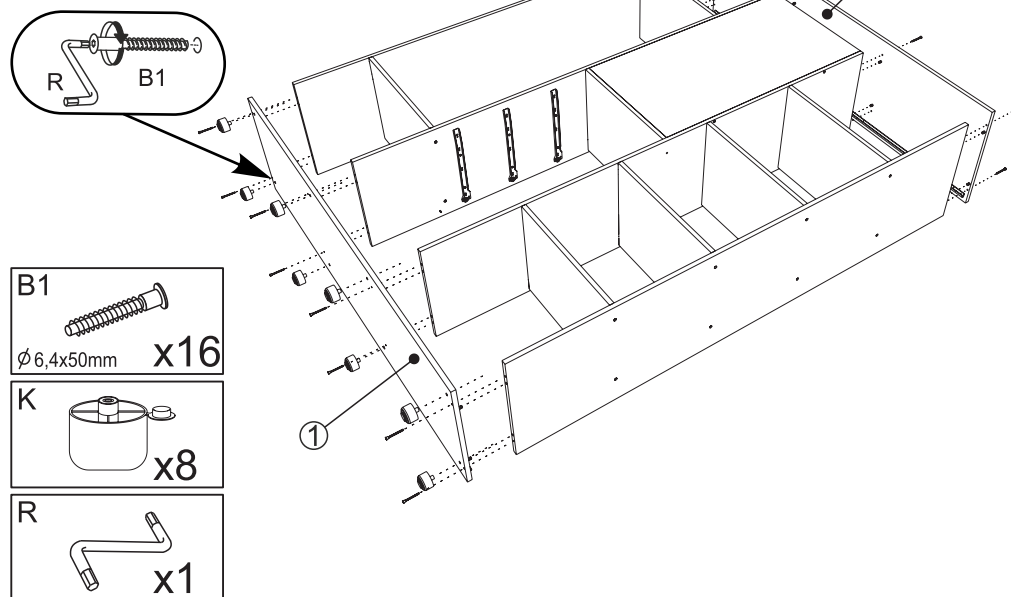

B1
Ø 6,4x50mm x16

K
x8

R
x1

4

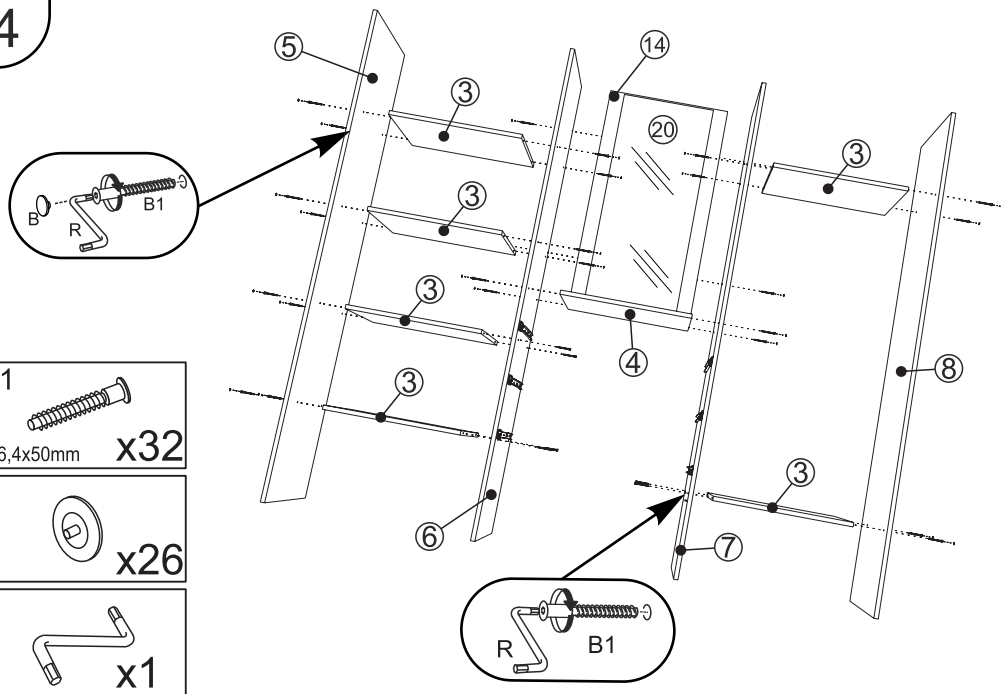

B1
Ø 6,4x50mm x32

B
x26

R
x1

6

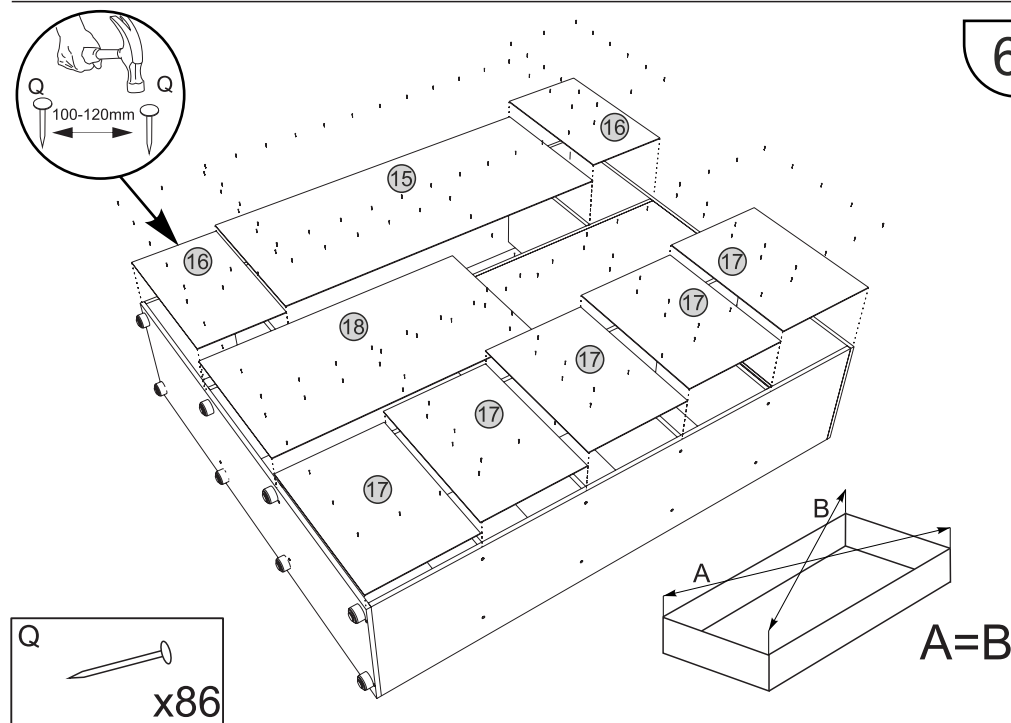

Q
x86

A=B

3

5

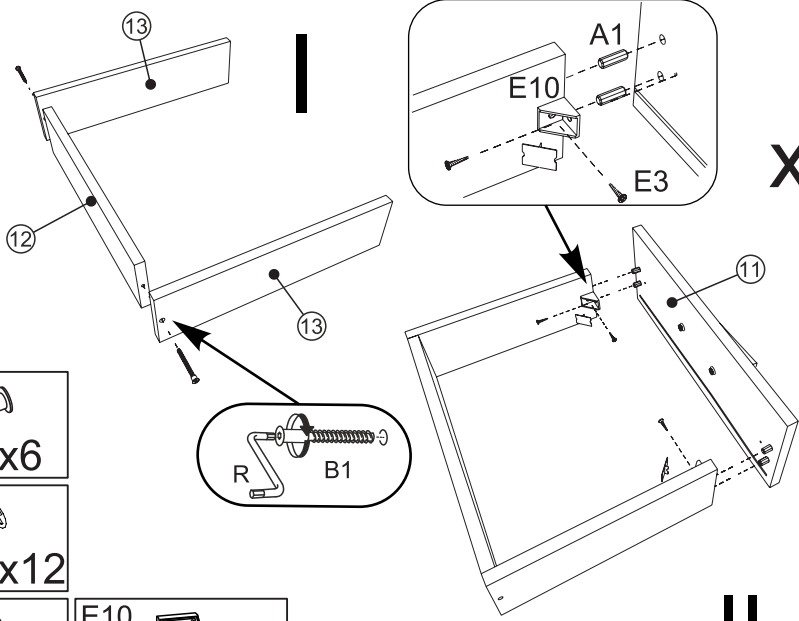

B1
 Ø 6,4x50mm x6

E3
 Ø 3.5x16 mm x12

R x1

E10 x6

x3

II

Hallway Angelina
 Передпокої Ангеліна

7

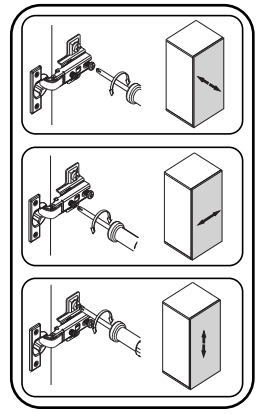

P2
 L=350mm x1

L3 x2

E3
 Ø 3.5x16 mm x16

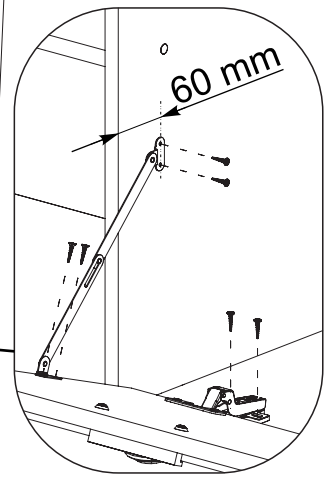
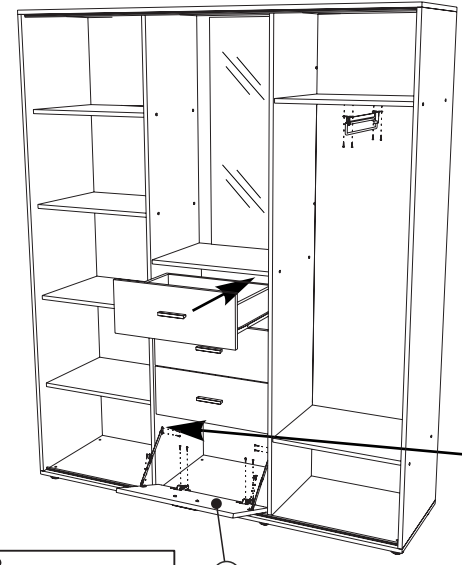

6

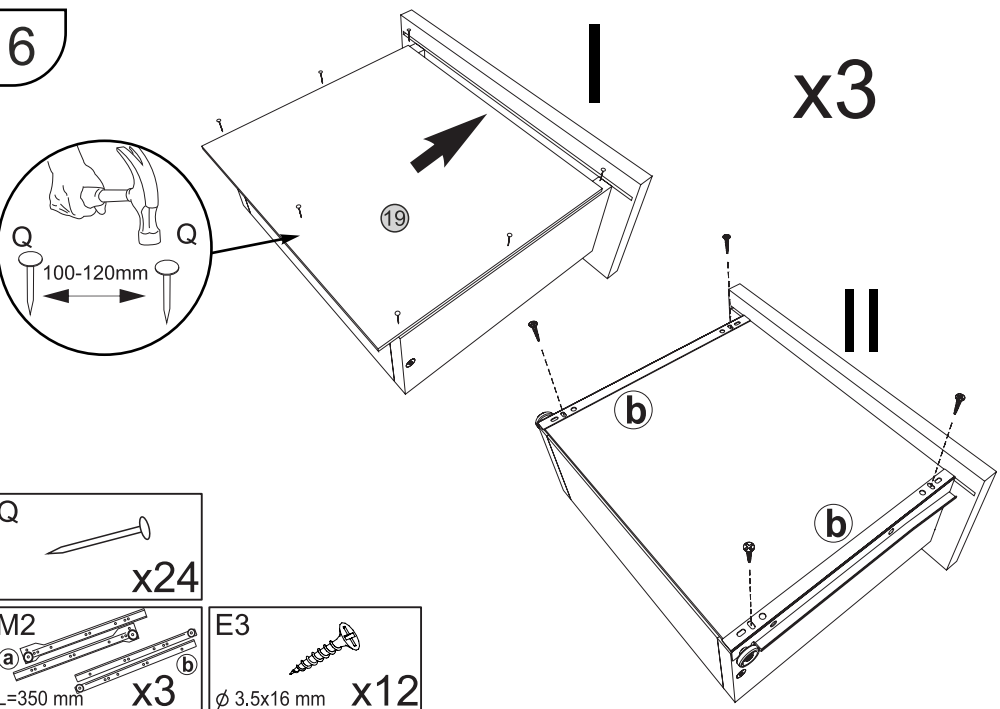

Q x24

M2
 L=350 mm x3

E3
 Ø 3.5x16 mm x12

x3

II

8

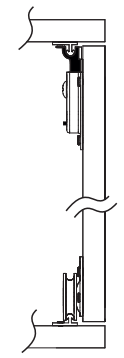
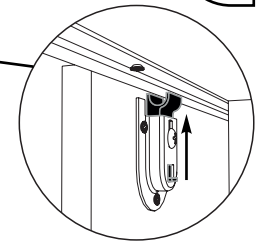
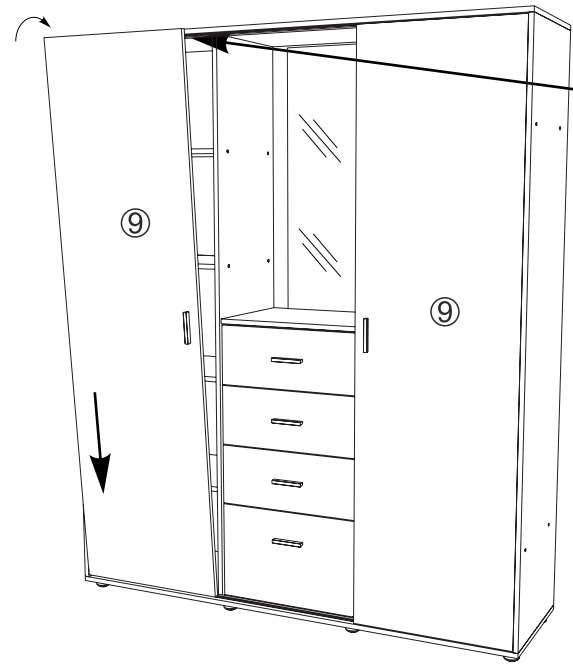

4

Hallway Angelina
Передпокій Ангеліна

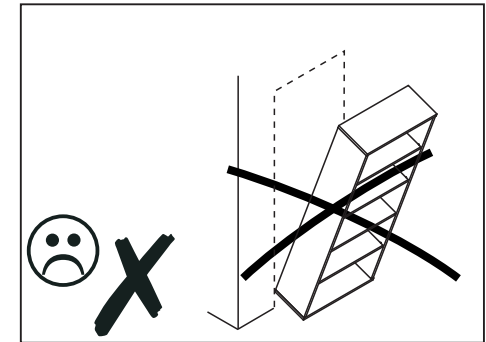
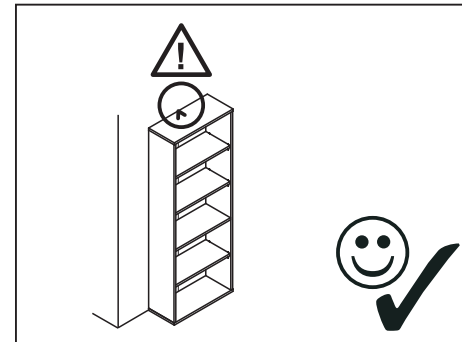
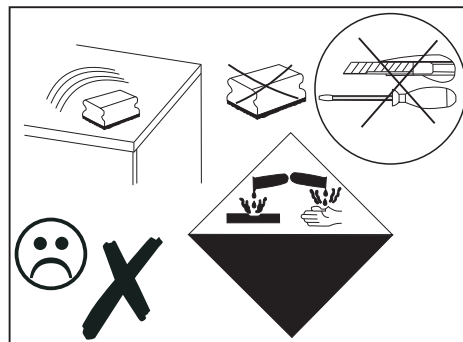
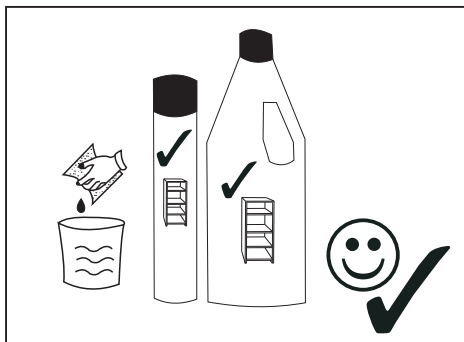
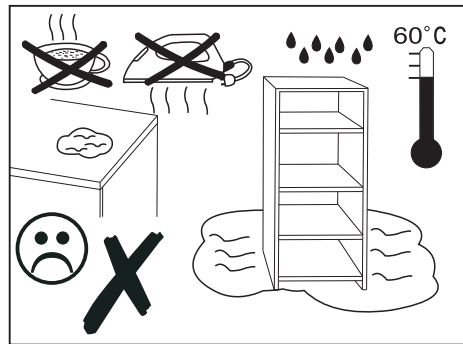
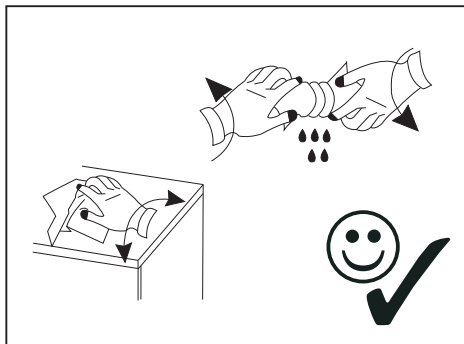
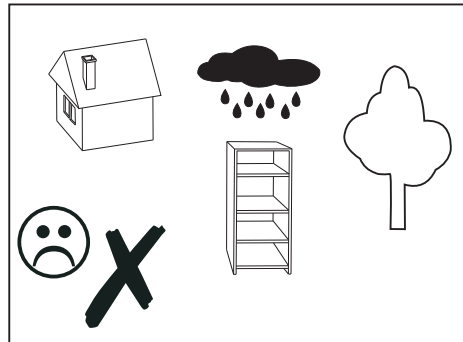
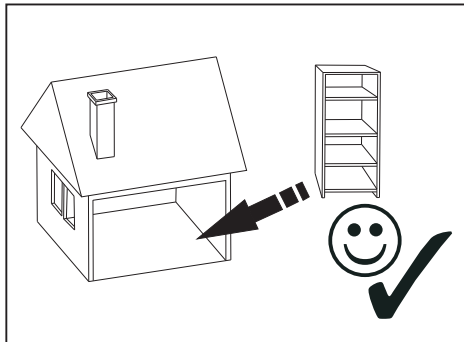

Important information
Read carefully.
Keep this information for further reference.

GB WARNING

Serious or fatal crushing injuries can occur from furniture tip-over. To prevent this furniture from tipping over it must be permanently fixed to the wall.

Fixing devices for the wall are not included since different wall materials require different types of fixing devices. Use fixing devices suitable for the walls in your home. For advice on suitable fixing systems, contact your local specialized dealer.

Wichtige Information
Sorgfältig lesen
Diese Information aufbewahren

DE ACHTUNG

Wenn Möbelstücke umkippen, können ernste oder lebensgefährliche Verletzungen durch Einklemmen die Folge sein. Um zu verhindern, dass das Möbelstück umkippt, muss es fest an der Wand verankert werden.

Beschläge für die Wandbefestigung sind nicht beigegeben, da sie von der jeweiligen Wandbeschaffenheit abhängig sind. Befestigungsbeschläge benutzen, die für die heimischen Wände geeignet sind. Bei diesbezüglichen Fragen den örtlichen Fachhandel zu Rate ziehen.

Ważne informacje
Przeczytaj uważnie.
Zachowaj ulotkę na przyszłość.

PL UWAGA

Przewrócenie sięmebli może doprowadzić do poważnych obrażeń lub śmierci. Aby zapobiec przewróceniu sięmebla, należy na stałe przymocować go dościany.

W zestawie nie znajdują się narzędzia mocujące, ponieważ wymagają one różnych typów śrub. Użyj śrub odpowiednich dościan w Twoim domu. W przypadku wątpliwości, jakich śrub użyć, skontaktuj się z najbliższym specjalistycznym sklepem.

Information importante
Lire attentivement.
Conserver ces informations pour un usage ultérieur.

FR AVERTISSEMENT

Risque de blessure grave en cas de chute du meuble. Pour éviter que le meuble ne bascule, il faut le fixer aumur de façon permanente.

Les fixations ne sont pas incluses car leur choix dépend du matériau du mur sur lequel est fixé le meuble. Utilisez des fixations adaptées au matériau du mur. Pour obtenir des conseils sur les fixations utiliser, adressez-vous a un revendeur spécialisé.

Informații importante
Citește cu atenție.
Păstreazăaceste informații pentru referințe ulterioare.

RO ATENȚIE

Pot surveni răni grave dacăte împiedici de obiectele de mobilier. Pentru prevenirea rănilor, fixeazămobila pe perete.

Accesorile de fixare pentru perete nu sunt incluse deoarece materialele diferite din care sunt făcuți pereteii au nevoie de accesorii diferite de fixare. Folosește accesorile de fixare potrivite pentru pereții camerei tale. Contacteazăun specialist dacănuștii care sunt accesorile potrivite pereților casei tale.

Важлива інформація
Прочитайте уважно
Збережіть цю інструкцію

UA УВАГА

Падіння незакріплених меблів може спричинити серйозне або смертельне травмування людини. Щоб запобігти перекиданню цих меблів, їх слід міцно прикріпити до стіни

Кріплення до стіни не додаються, оскільки різні матеріали потребують різних кріплень. Використовуйте кріпильні пристрої, які пасують матеріалу Ваших стін. За порадою щодо належних систем кріплення звертайтеся у місцеву спеціалізовану крамницю.