

(ENG)

# Shelf "P-33"

(UA)



# Полиця "П-33"



885mm

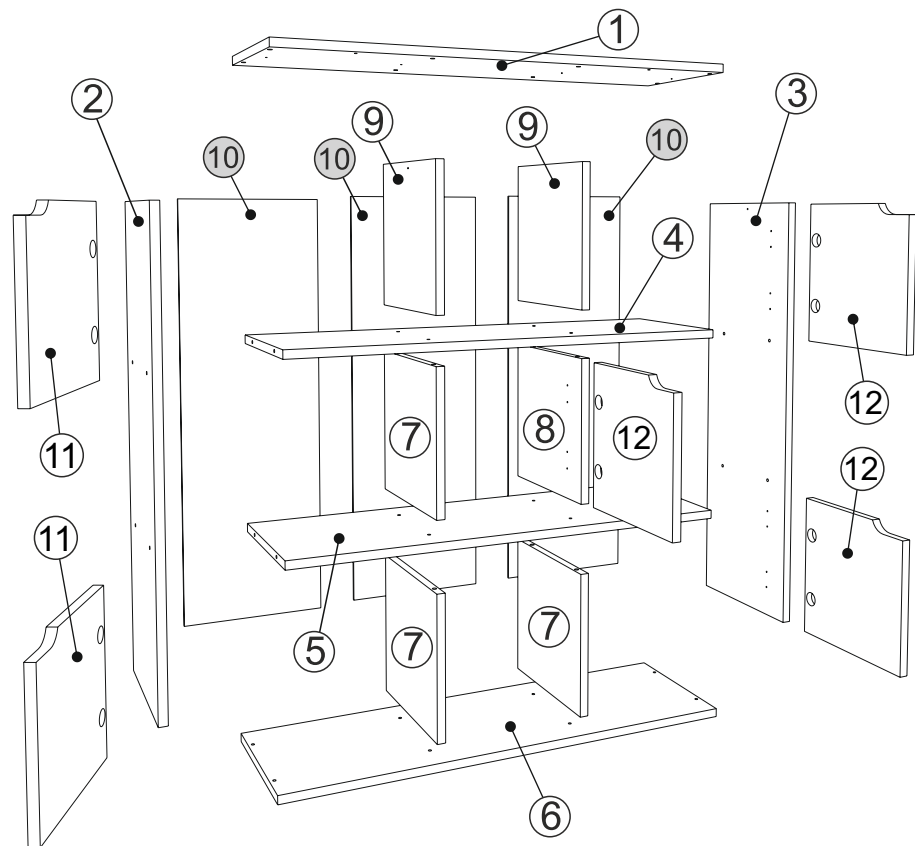
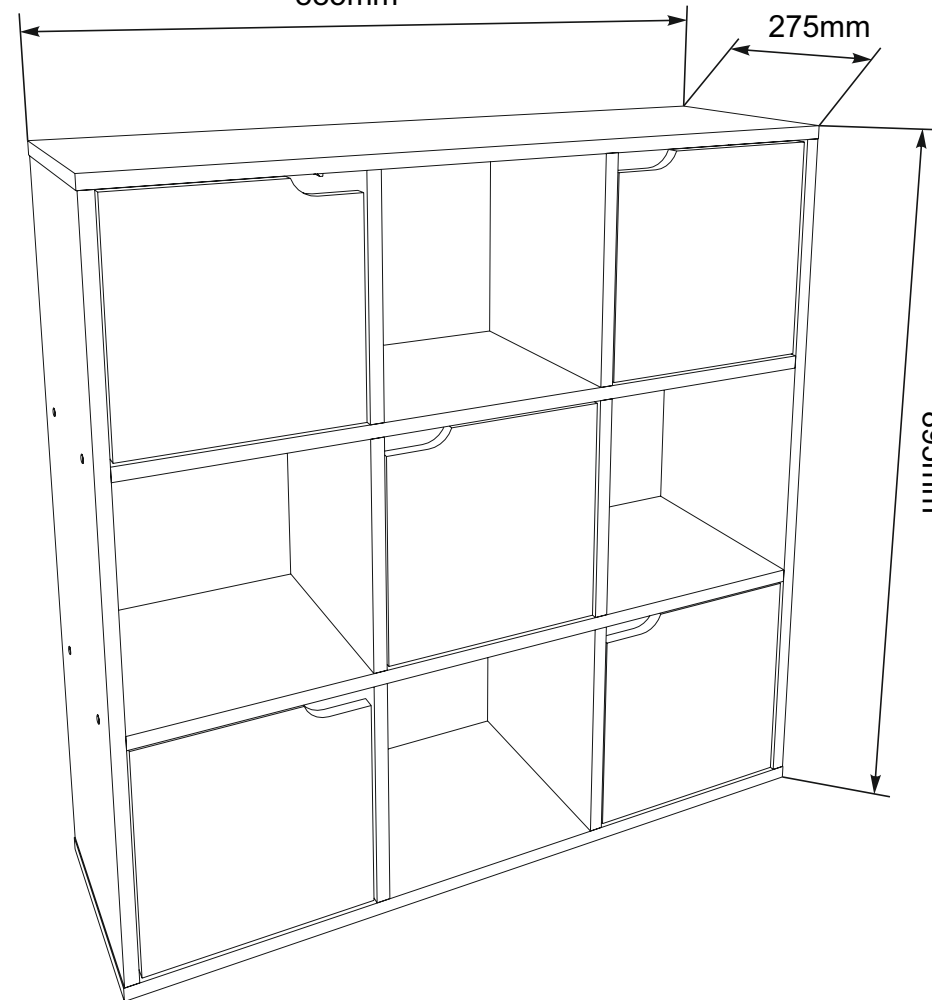

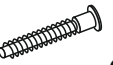
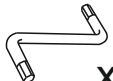
275mm



895mm



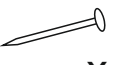

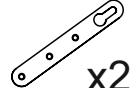
<b>B1</b>  ø 6,4x50mm <b>x24</b>	<b>R</b>  <b>x1</b>	<b>B</b>  <b>x16</b>
--	---	--

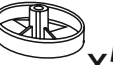
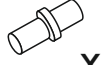
<b>L5</b>  ø 26 <b>x10</b>	<b>E10</b>  <b>x4</b>	<b>E1</b>  ø 3,5x25mm <b>x12</b>
---	--	---

<b>Q</b>  <b>x40</b>	<b>E8</b>  <b>x2</b>	<b>S3</b>  <b>x2</b>
---	---	---

<b>K1</b>  <b>x5</b>	<b>J</b>  <b>x5</b>	<b>A1</b>  ø 8x30 <b>x16</b>
---	--	---

<b>S5</b>  <b>x6</b>	<b>E3</b>  ø 3.5x16 mm <b>x48</b>
---	--



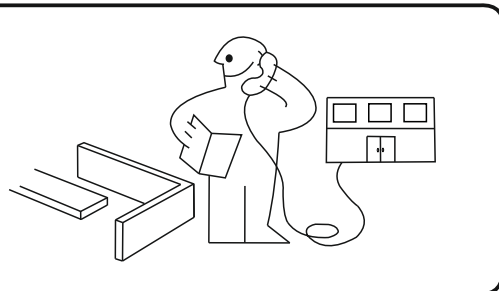
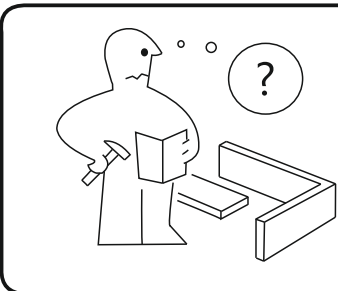
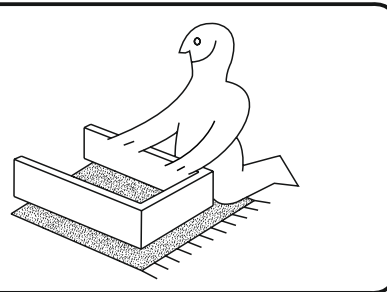
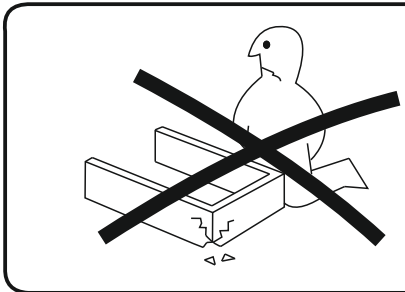
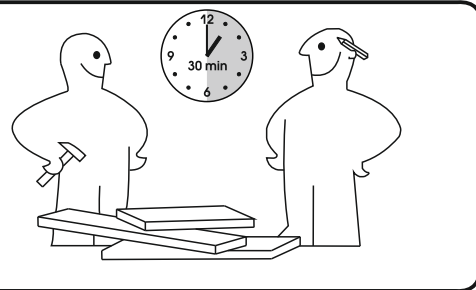
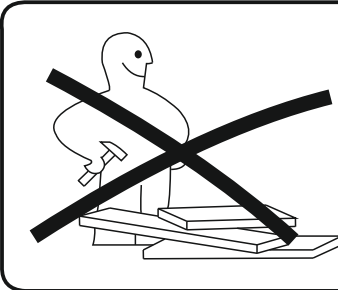
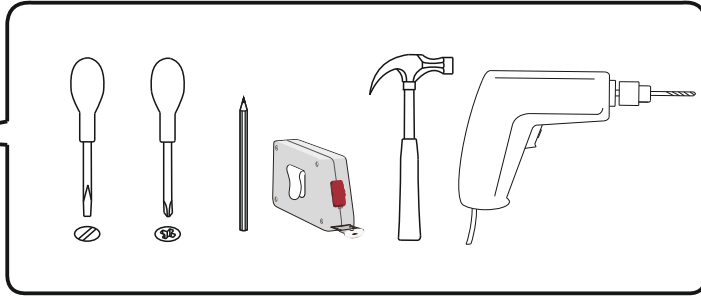
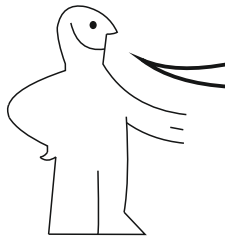

№	a x b	x
1	885X275	1
2	851X275	1
3	851X275	1
4	851X275	1
5	851X275	1
6	885X275	1
7	275X273	3
8	275X273	1
9	275X273	2
10	879X290	3
11	267X267	2
12	267X267	3

# Shelf "P-33" Полиця "П-33"

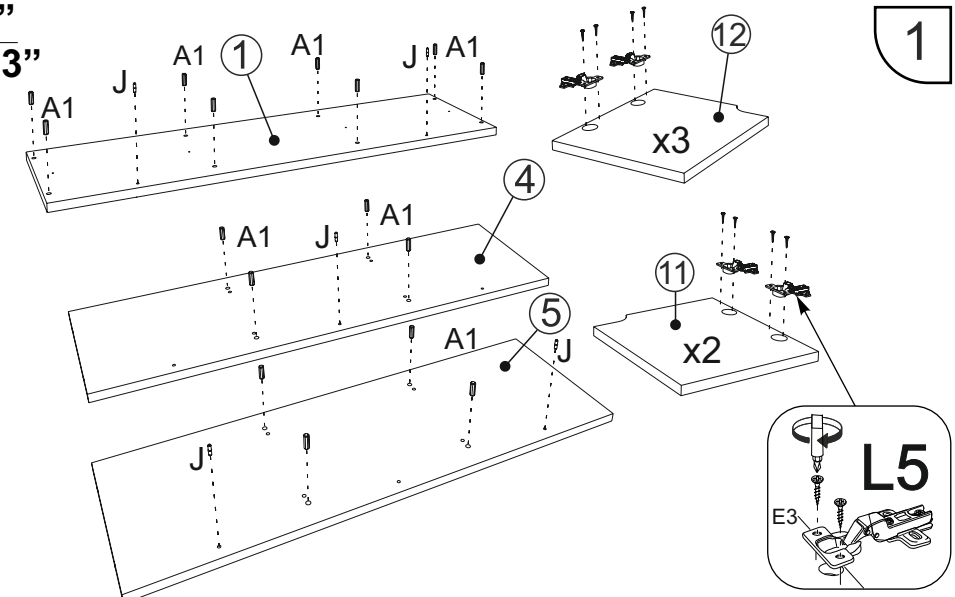

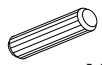

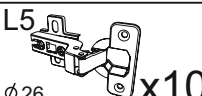

1

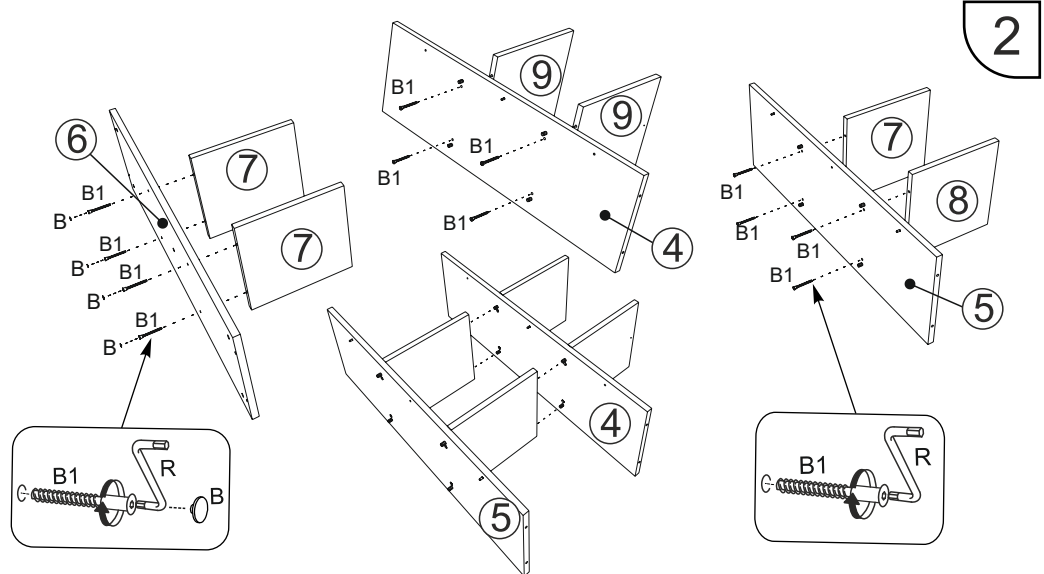

- A1**  
  
 $\varnothing 8 \times 30$     **x16**
- J**  
  
**x5**
- L5**  
  
 $\varnothing 26$     **x10**
- E3**  
  
 $\varnothing 3.5 \times 16 \text{ mm}$     **x20**

2



- B1**  
  
 $\varnothing 6,4 \times 50 \text{ mm}$     **x12**
- R**  
  
**x1**
- B**  
  
**x4**

2

3

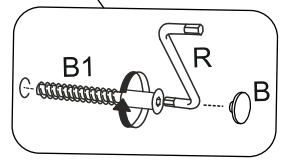
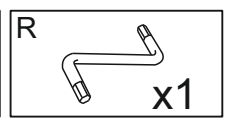
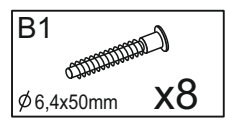
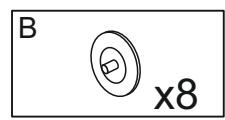
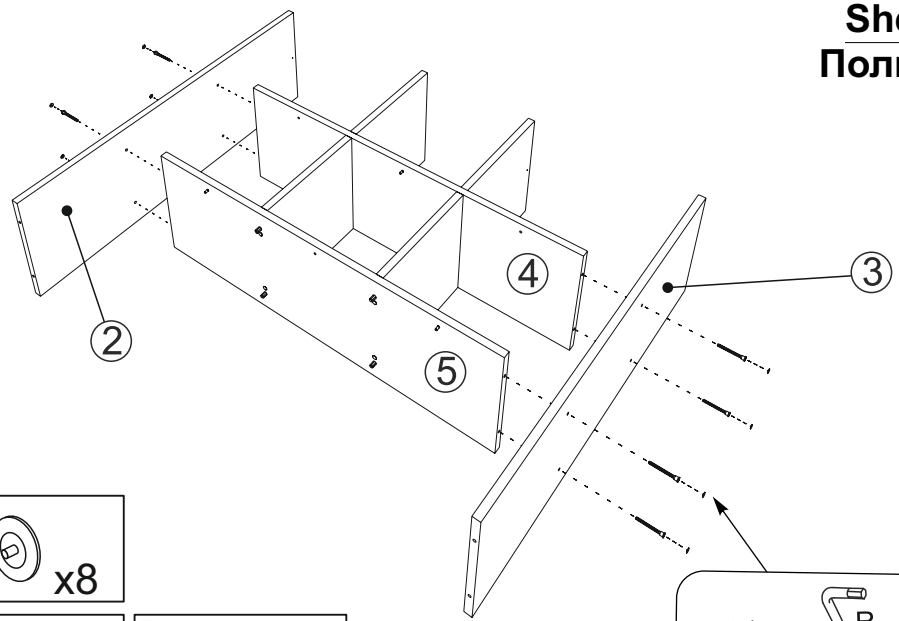

**Shelf "P-33"**  
**Полиця "П-33"**

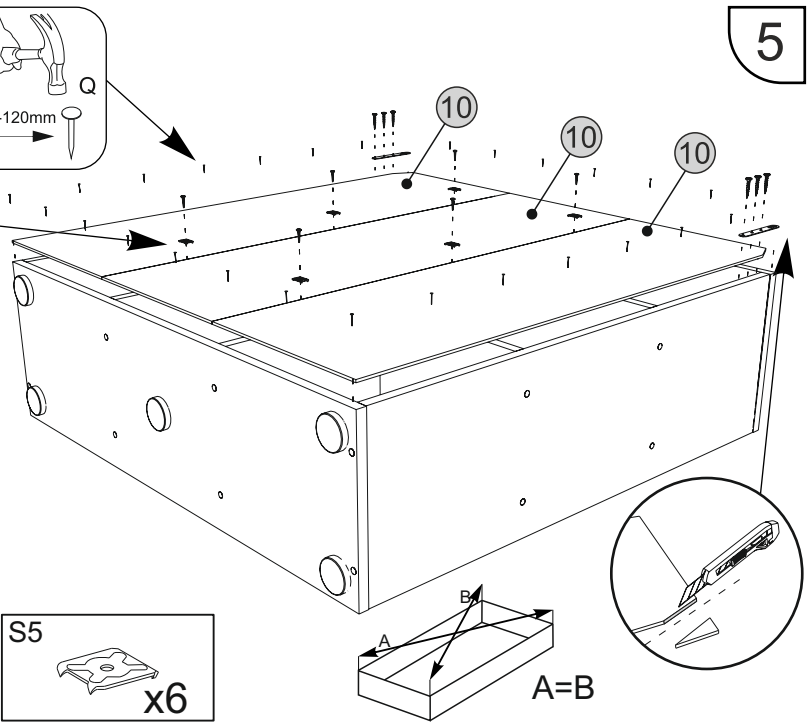
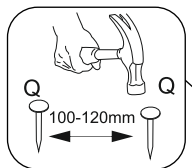
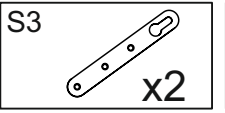
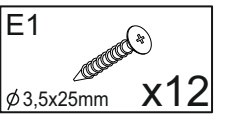
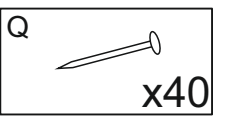
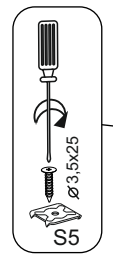

5

4

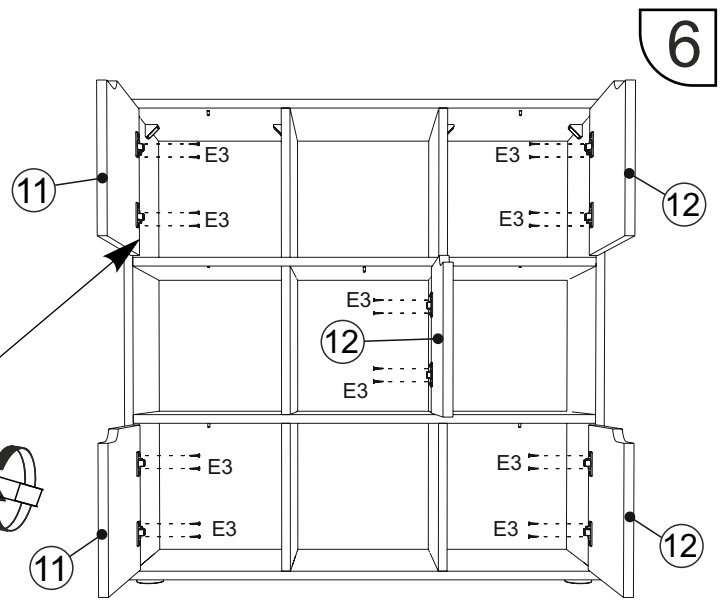
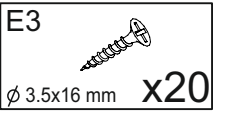
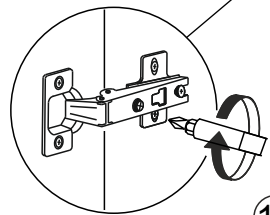
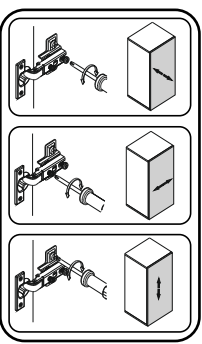
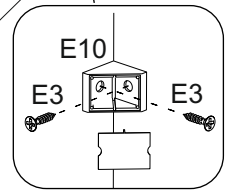
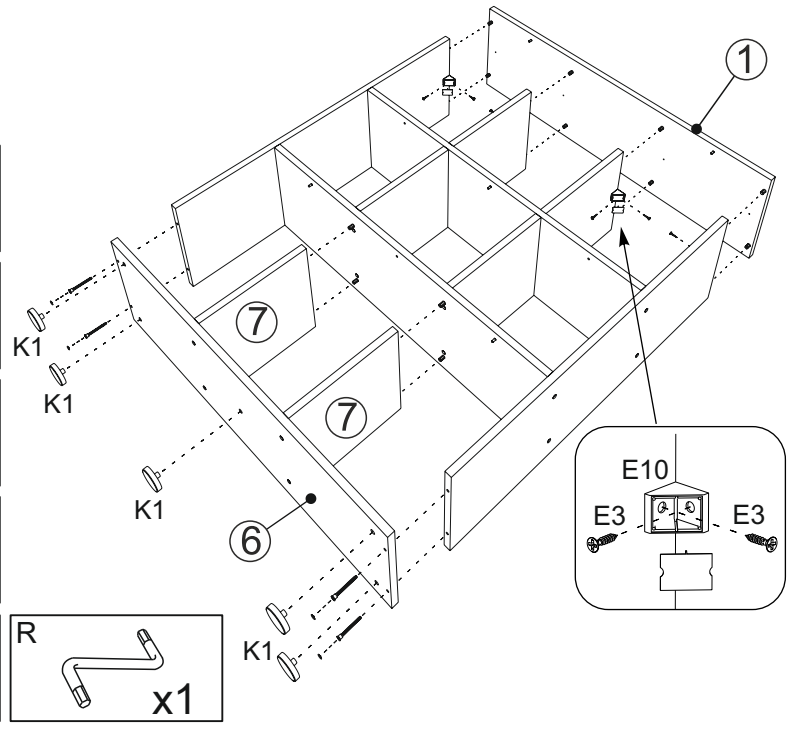
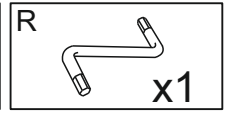
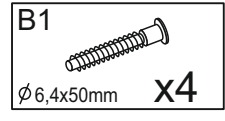
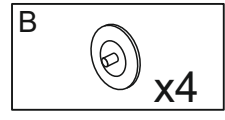
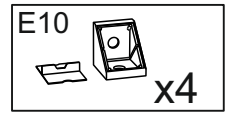
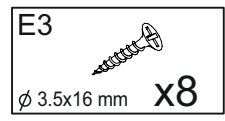
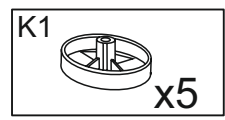

6

3

Shelf "P-33"  
Полиця "П-33"

