

No	a x b	x	No	a x b	x
1	803x380	1	16		
2	767x80	2	17		
3	875x351	1	18		
4	875x351	1	19		
5	767x60	1	20		
6	350x100	10	21		
7	710x100	5	22		
8	796x155	5	23		
9	825x396	2	24		
10	736x350	5	25		
11			26		
12			27		
13			28		
14			29		
15			30		

(ENG) **Commode "Commode-5L"**

(UA) **Комод "Комод-5L"**

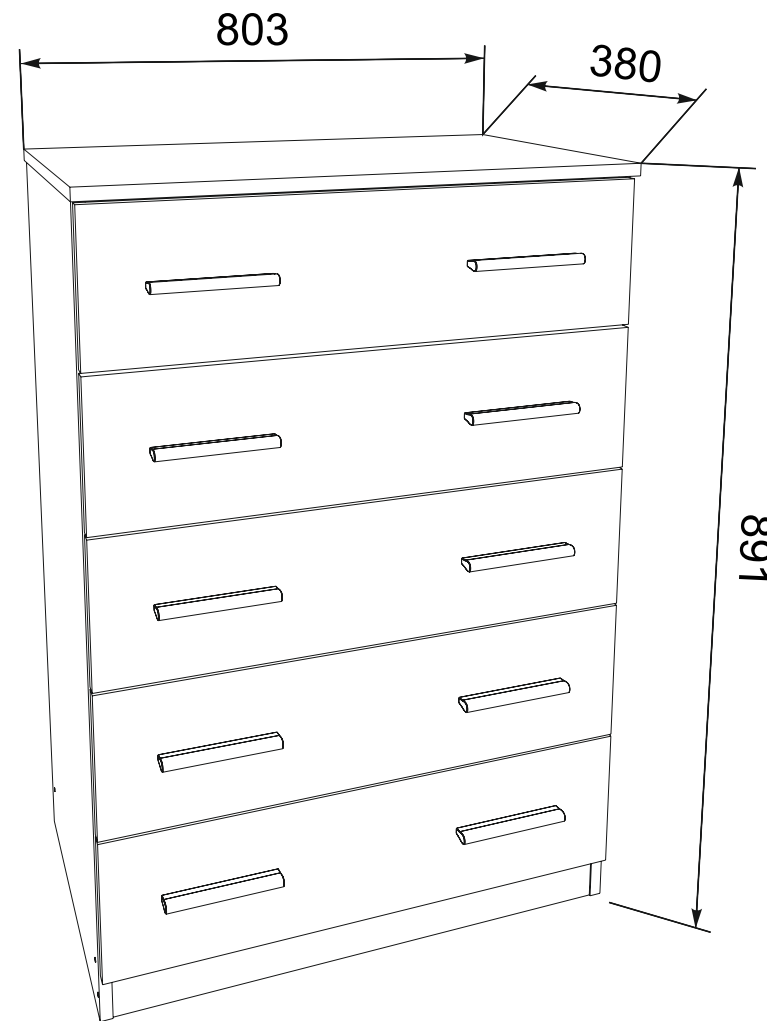

Commode "Commode-5L"

Комод "Комод-5L"

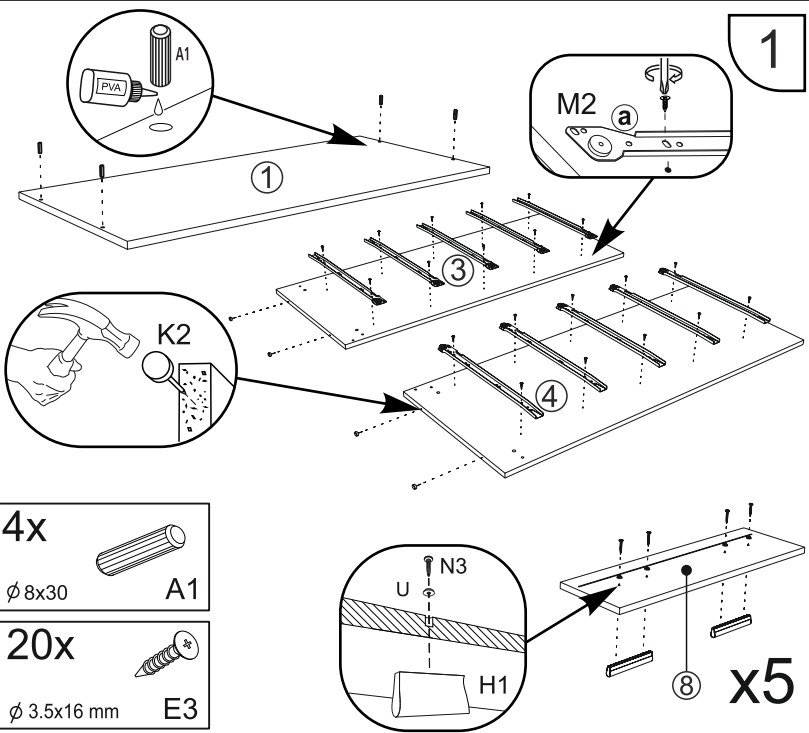
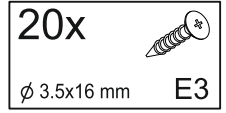
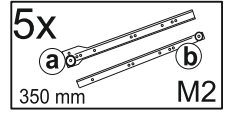
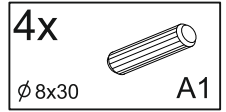
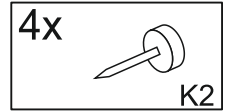
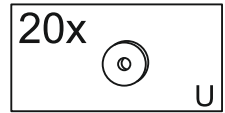
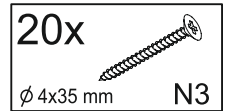
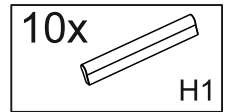
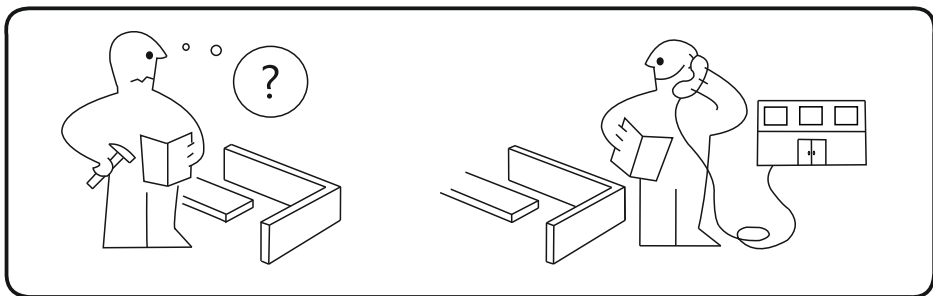
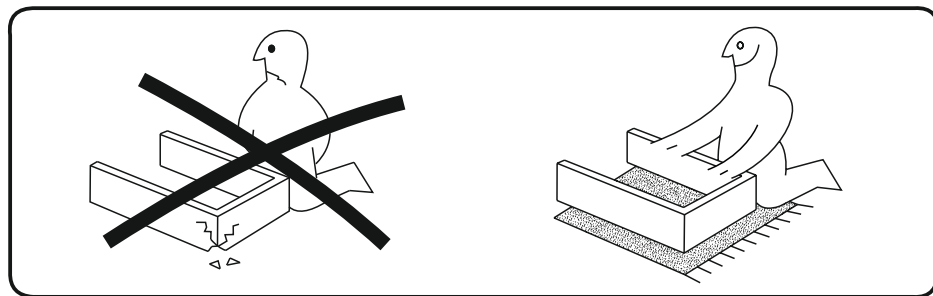
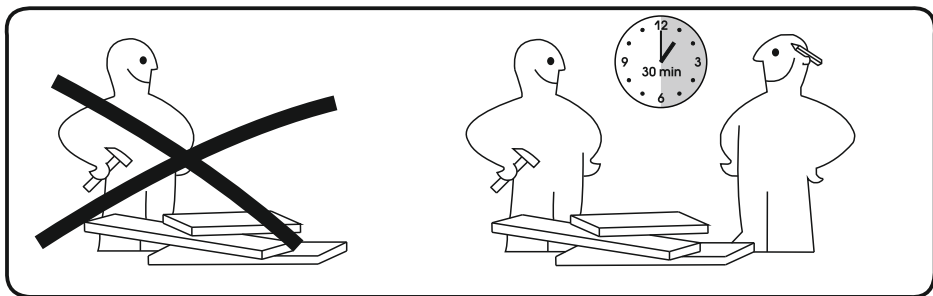
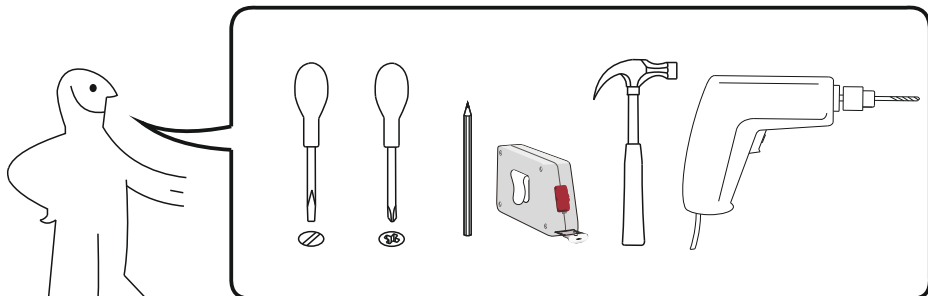

1

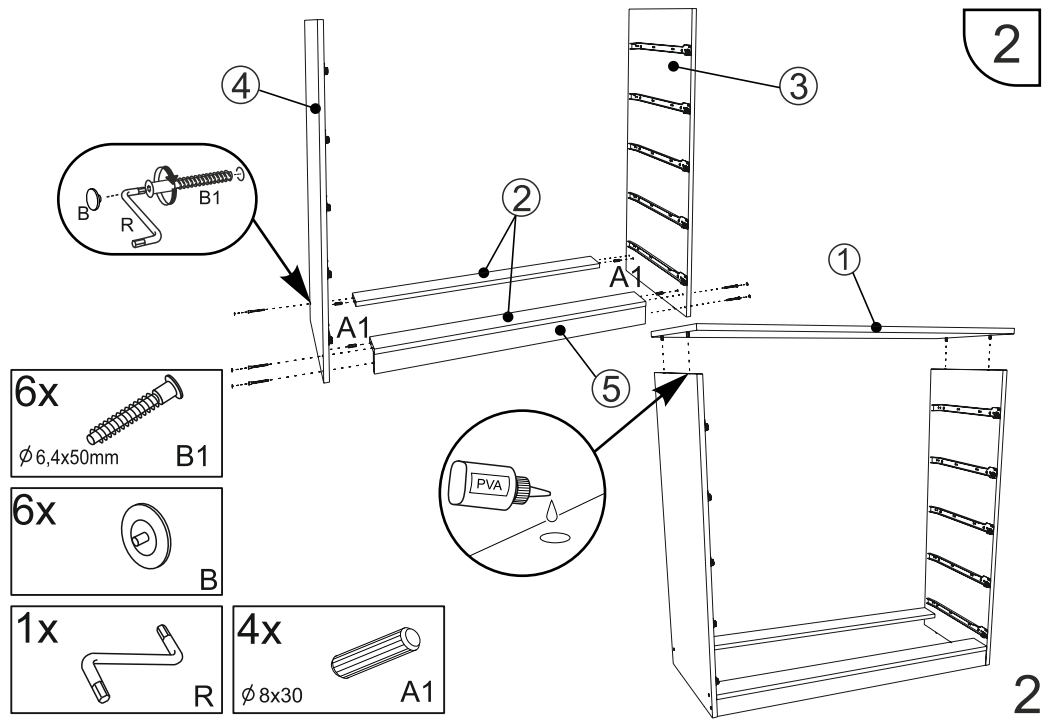

2

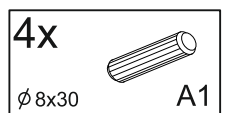
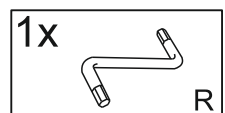
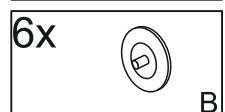
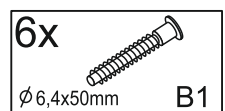

2

3

Commode "Commode-5L"

Комод "Комод-5L"

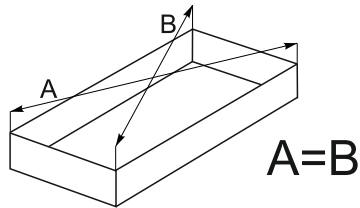
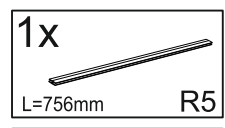
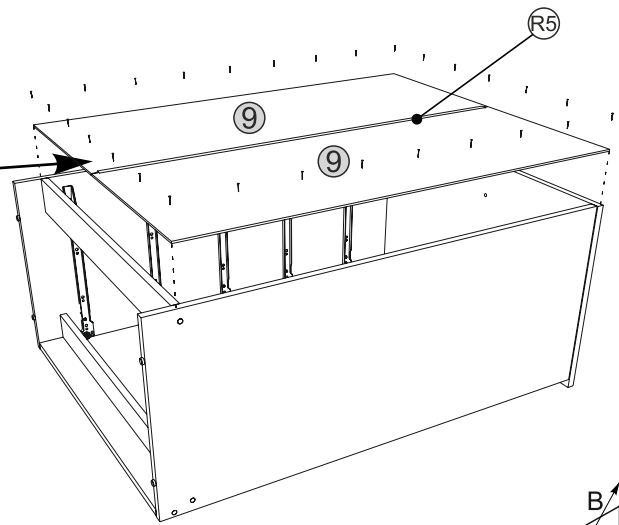
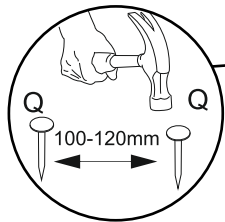

5

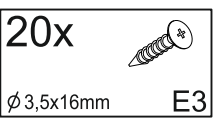
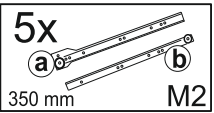
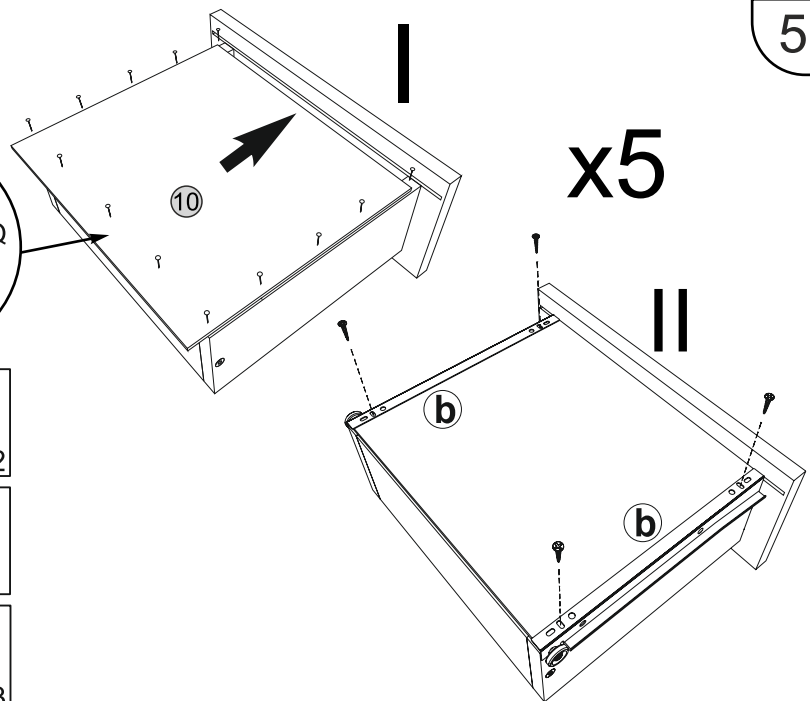
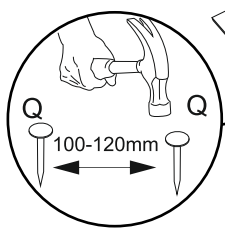

4

x5

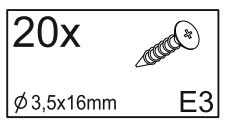
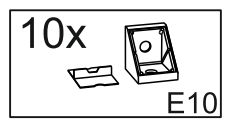
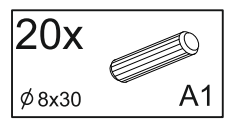
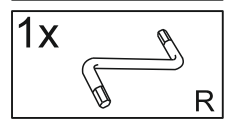
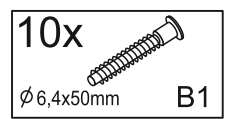
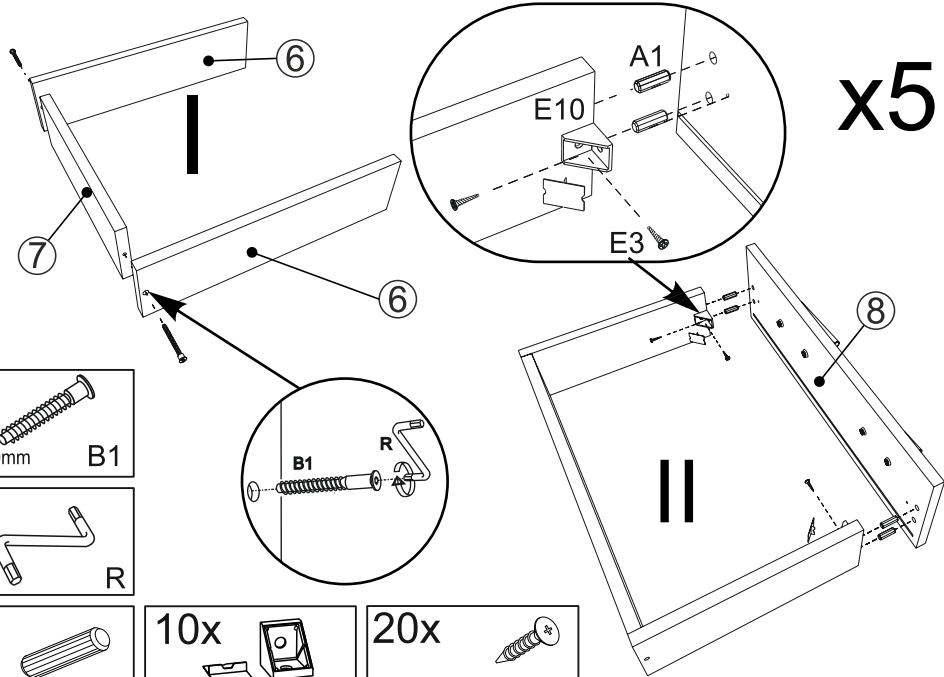

6

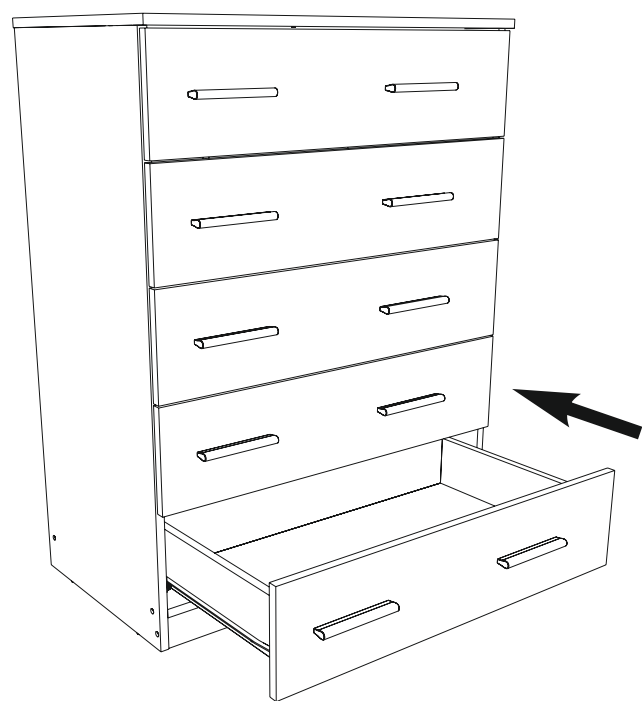

Commode "Commode-5L"

Комод "Комод-5L"

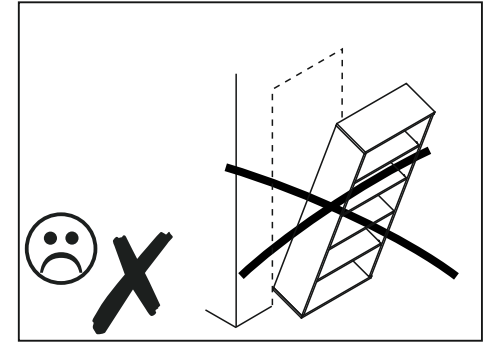
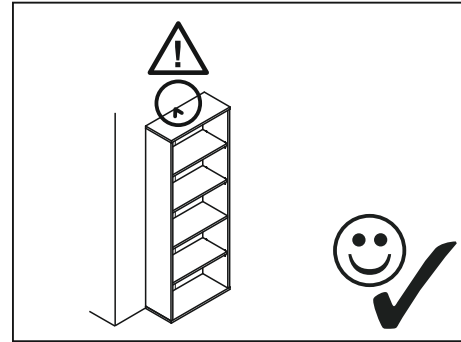
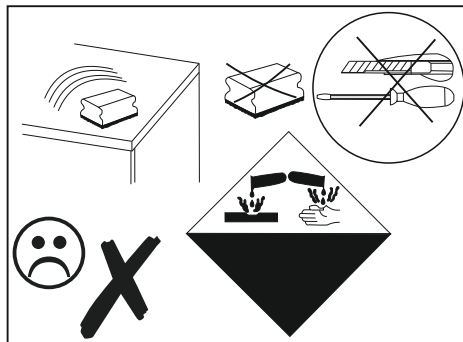
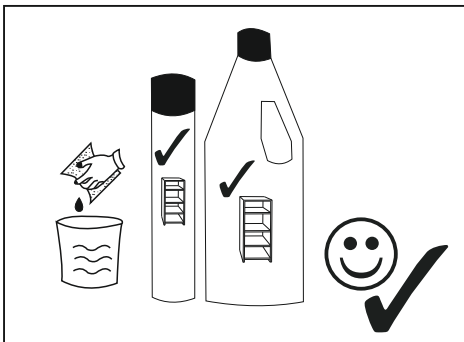
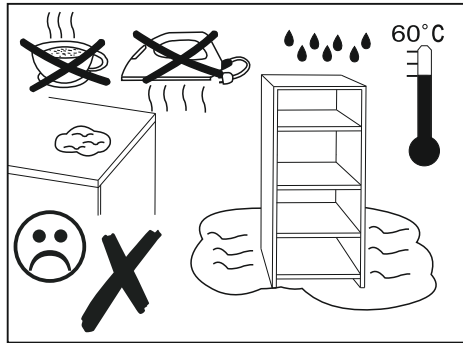
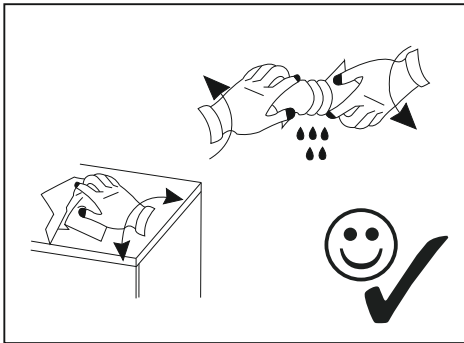
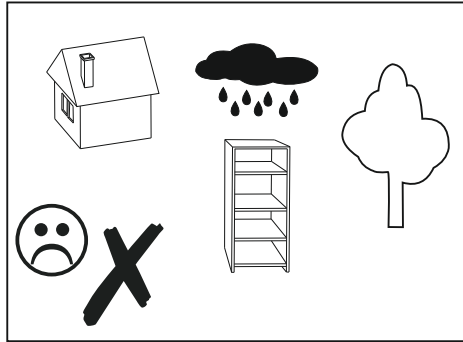
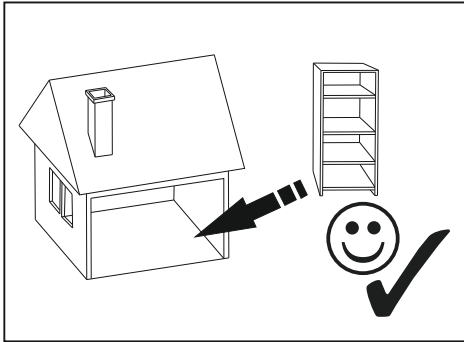

Important information
Read carefully.
Keep this information for further reference.

GB WARNING

Serious or fatal crushing injuries can occur from furniture tip-over. To prevent this furniture from tipping over it must be permanently fixed to the wall.

Fixing devices for the wall are not included since different wall materials require different types of fixing devices. Use fixing devices suitable for the walls in your home. For advice on suitable fixing systems, contact your local specialized dealer.

Wichtige Information
Sorgfältig lesen
Diese Information aufbewahren

DE ACHTUNG

Wenn Möbelstücke umkippen, können ernste oder lebensgefährliche Verletzungen durch Einklemmen die Folge sein. Um zu verhindern, dass das Möbelstück umkippt, muss es fest an der Wand verankert werden.

Beschläge für die Wandbefestigung sind nicht beigegeben, da sie von der jeweiligen Wandbeschaffenheit abhängig sind. Befestigungsbeschläge benutzen, die für die heimischen Wände geeignet sind. Bei diesbezüglichen Fragen den örtlichen Fachhandel zu Rate ziehen.

Ważne informacje
Przeczytaj uważnie.
Zachowaj ulotkę na przyszłość.

PL UWAGA

Przewrócenie się mebli może doprowadzić do poważnych obrażeń lub śmierci. Aby zapobiec przewróceniu się mebla, należy na stałe przymocować go do ściany.

W zestawie nie znajdują się odpowiednie śruby mocujące, ponieważ różne rodzaje ścian wymagają różnych typów śrub. Użyj śrub odpowiednich dościan w Twoim domu. W przypadku wątpliwości, jakich śrub użyć, skontaktuj się z najbliższym specjalistycznym sklepem.

Information importante
A lire attentivement.
Conservet ces informations pour un usage ultérieur.

FR AVERTISSEMENT

Risque de blessure grave en cas de chute du meuble. Pour éviter que le meuble ne bascule, il faut le fixer au mur de façon permanente.

Les fixations ne sont pas incluses car leur choix dépend du matériau du mur sur lequel est fixé le meuble. Utilisez des fixations adaptées au matériau du mur. Pour obtenir des conseils sur les fixations à utiliser, adressez-vous à un revendeur spécialisé.

Informații importante
Citește cu atenție.
Păstrează aceste informații pentru referințe ulterioare.

RO ATENȚIE

Pot surveni răni grave dacăte împiedici de obiectele de mobilier. Pentru prevenirea rănilor, fixează mobila pe perete.

Accesorile de fixare pentru perete nu sunt incluse deoarece materialele diferite din care sunt făcuți pereteii au nevoie de accesorii diferite de fixare. Folosește accesorile de fixare potrivite pentru pereții camerei tale. Contactează un specialist dacă nu știi care sunt accesorile potrivite pereților casei tale.

Важлива інформація
Прочитайте уважно
Збережіть цю інструкцію

UA УВАГА

Падіння незакріплених меблів може спричинити серйозне або смертельне травмування людини. Щоб запобігти перекиданню цих меблів, їх слід міцно прикріпити до стіни

Кріплення до стіни не додаються, оскільки різні матеріали потребують різних кріплень. Використовуйте кріпильні пристрої, які пасують матеріалу Ваших стін. За порадою щодо належних систем кріплення звертайтеся у місцеву спеціалізовану крамницю.