

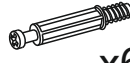









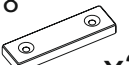

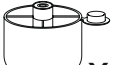

D  x6	C1  6x43 mm x6	E1  ø 3,5x25mm x6
K18  x2	S5  x6	D1  16 mm x6
K  x4	L4  x10	J  x4
B  x8	R  x1	F4  x2
B1  ø 6,4x50mm x8	A1  ø 8x30 x6	R4  L=862mm x1
S7  x1	E3  ø 3,5x16 mm x51	R5  L=1100mm L=765mm x1
E8  x1	Q  x50	C  M 4 x2

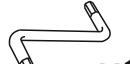
No	a x b	x
1	1888x530	1
2	1888x530	1
3	1138x428	2
4	900x530	1
5	900x530	1
6	866x512	1
7	866x502	1
8	701x428	2
9	80x866	1
10	1126x446	2
11	790x446	2

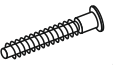
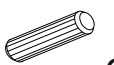
 - DVP/ДВП

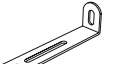
(ENG)

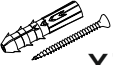
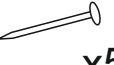
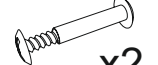
Wardrob "Wardrob-28"

(UA)

Шафа "Шафа-28"



Wardrob-28
Шафа-28

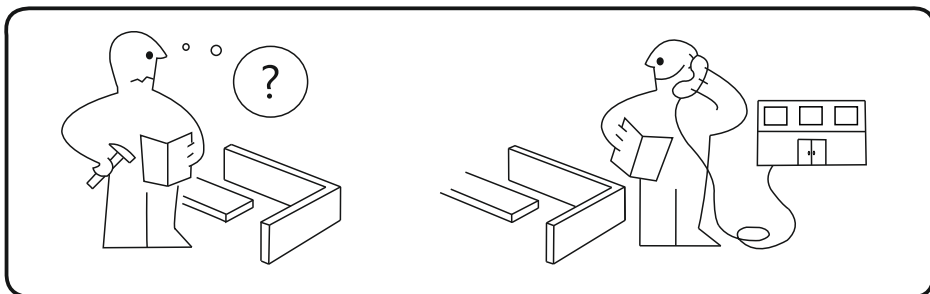
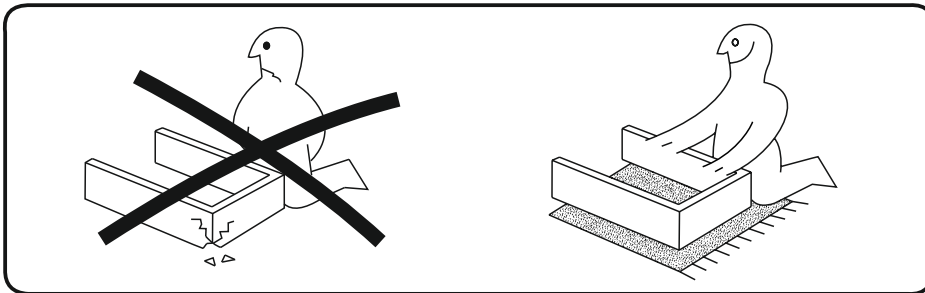
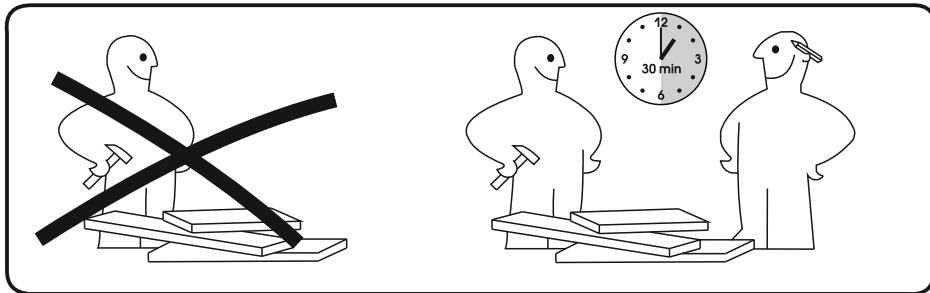

1

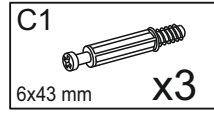
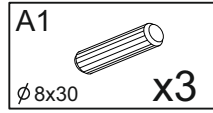
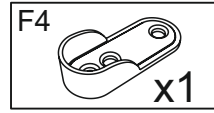
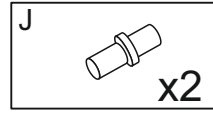
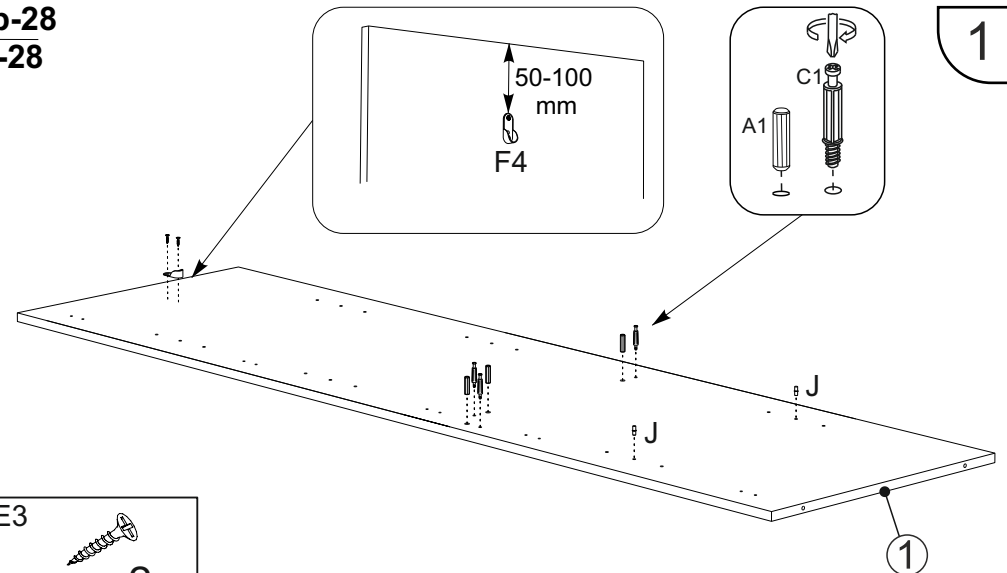

2

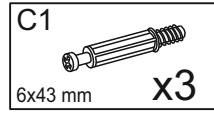
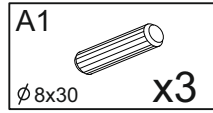
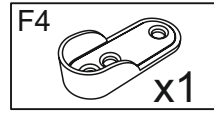
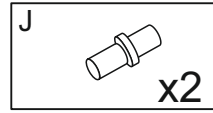
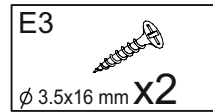
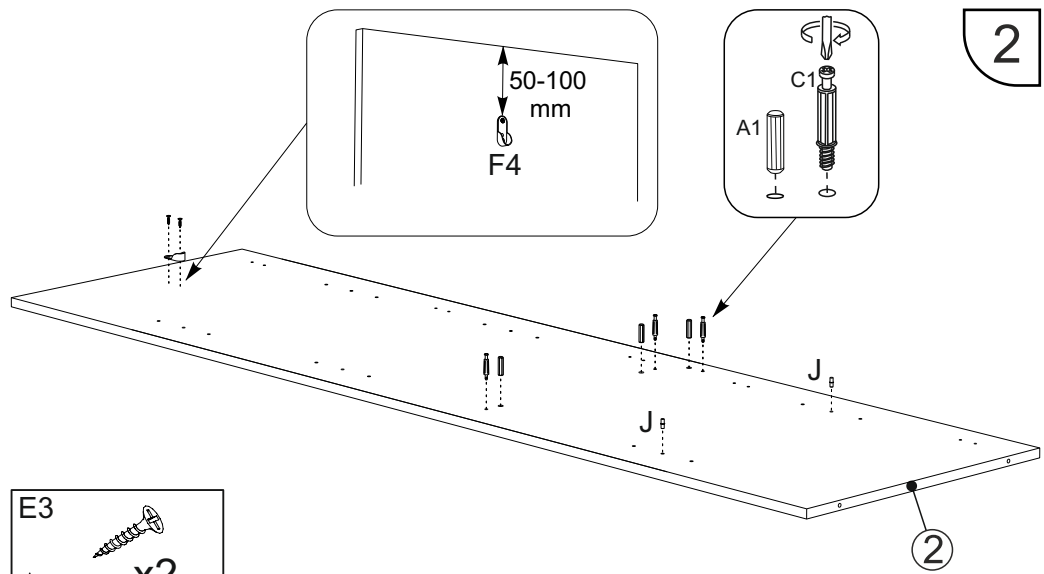

2

3

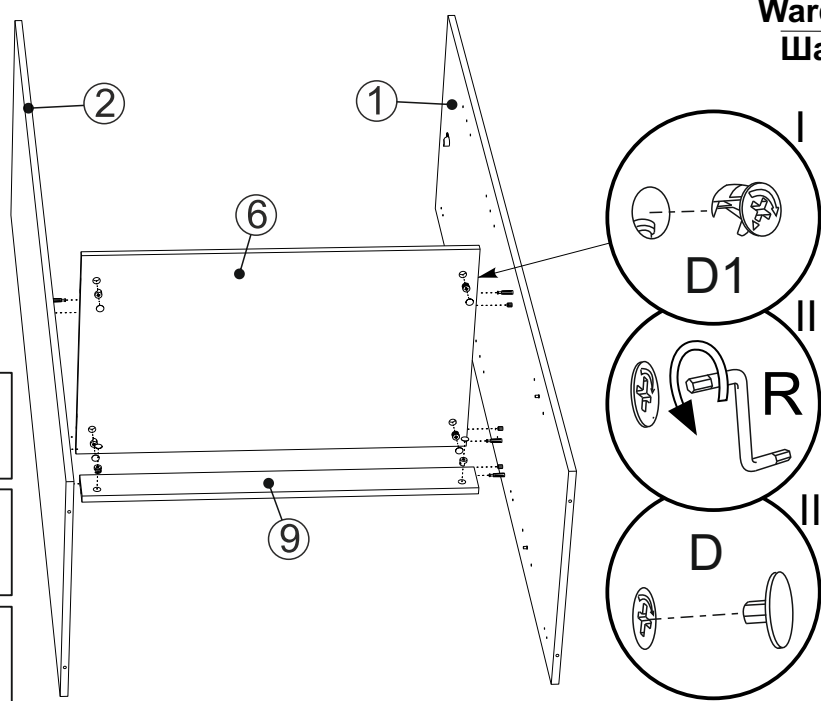

- D x6
- R x1
- D1 16 mm x6

Wardrob-28
Шафа-28

5

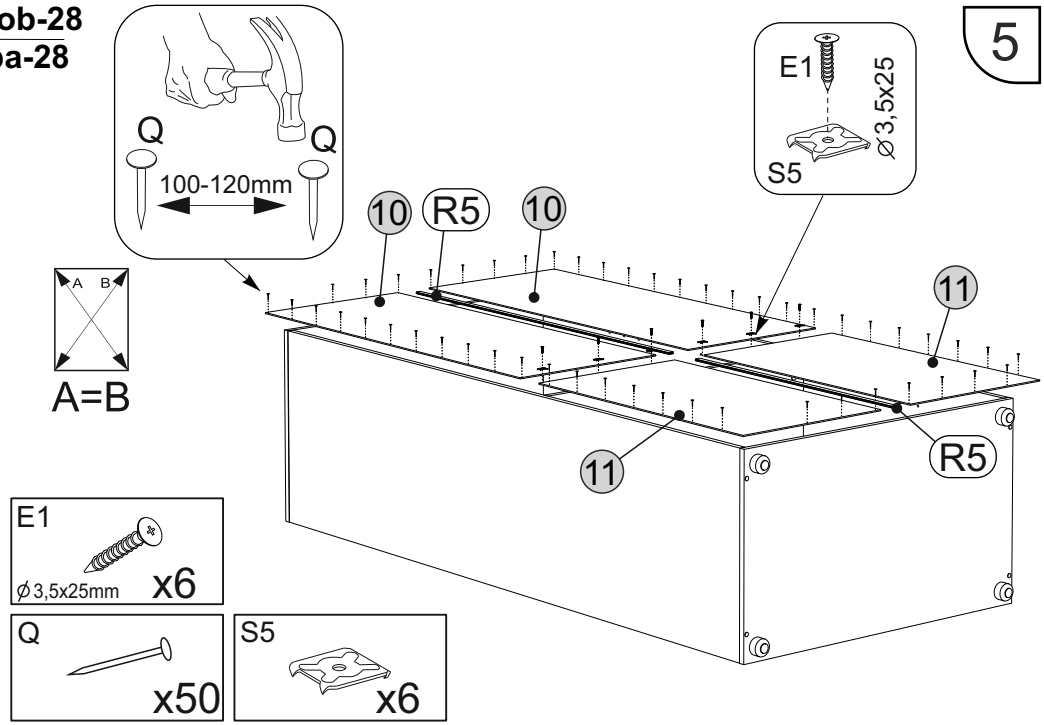

- E1 $\phi 3,5 \times 25 \text{mm}$ x6
- Q x50
- S5 x6

4

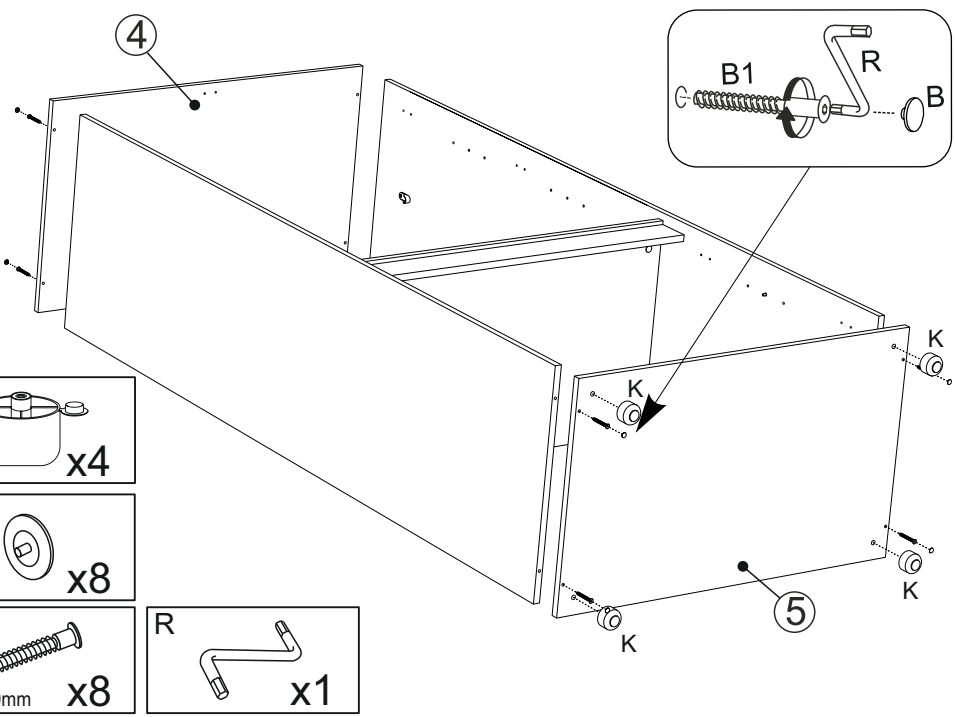

- K x4
- B x8
- B1 $\phi 6,4 \times 50 \text{mm}$ x8
- R x1

6

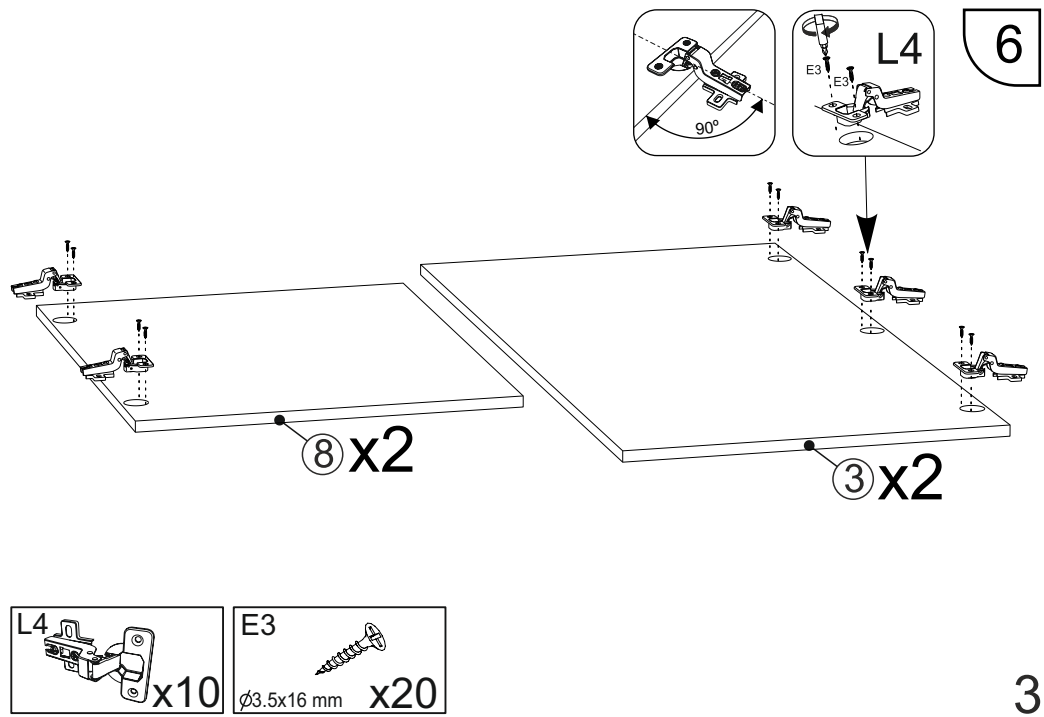

- L4 x10
- E3 $\phi 3,5 \times 16 \text{mm}$ x20

7

Wardrob-28 Шафа-28

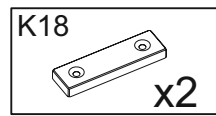
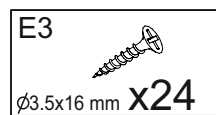
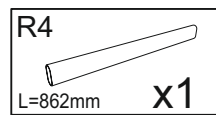
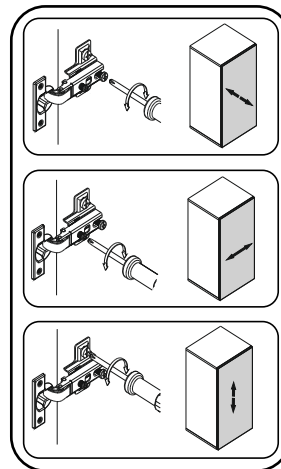
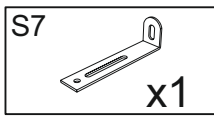
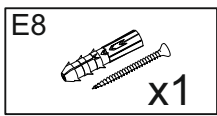
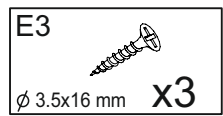
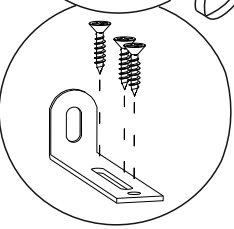
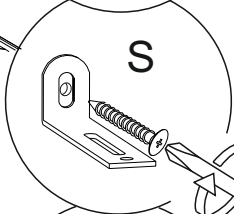
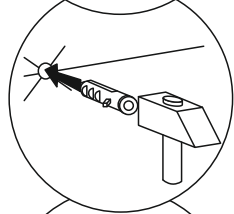
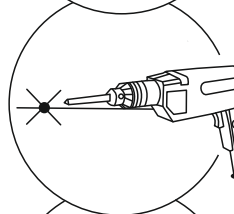
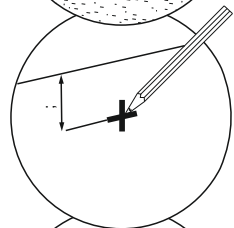
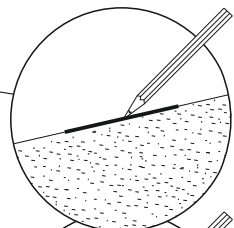
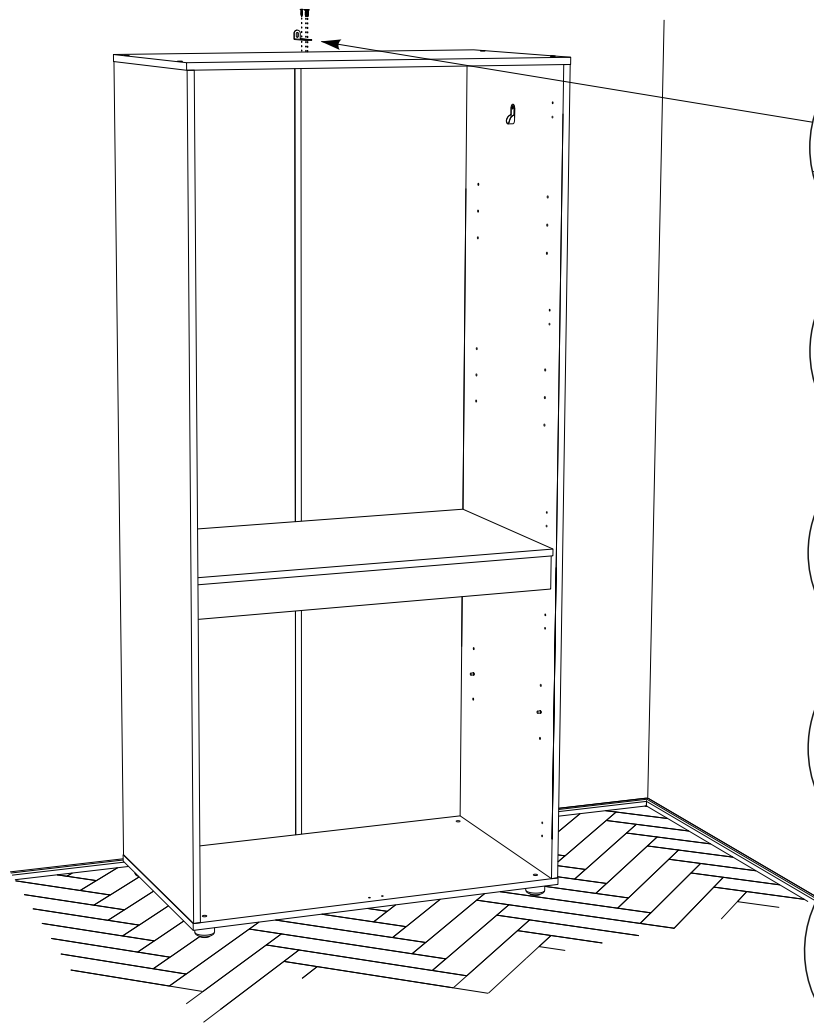

8

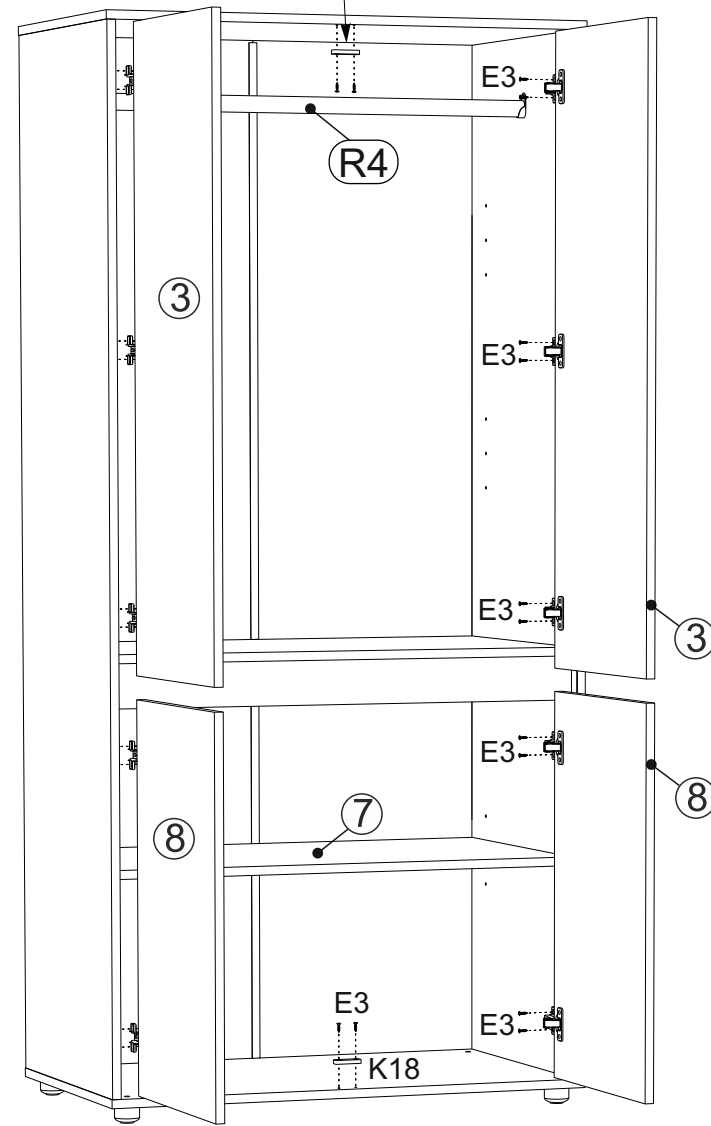
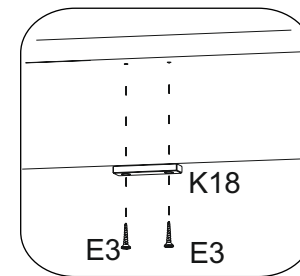

4

Wardrob-28
Шафа-28

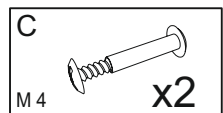
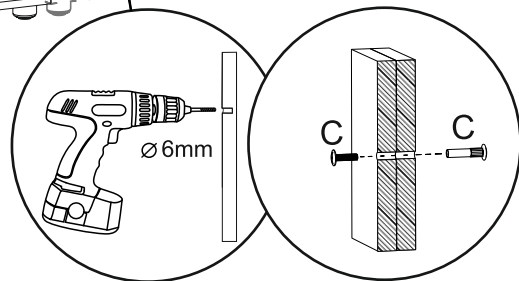
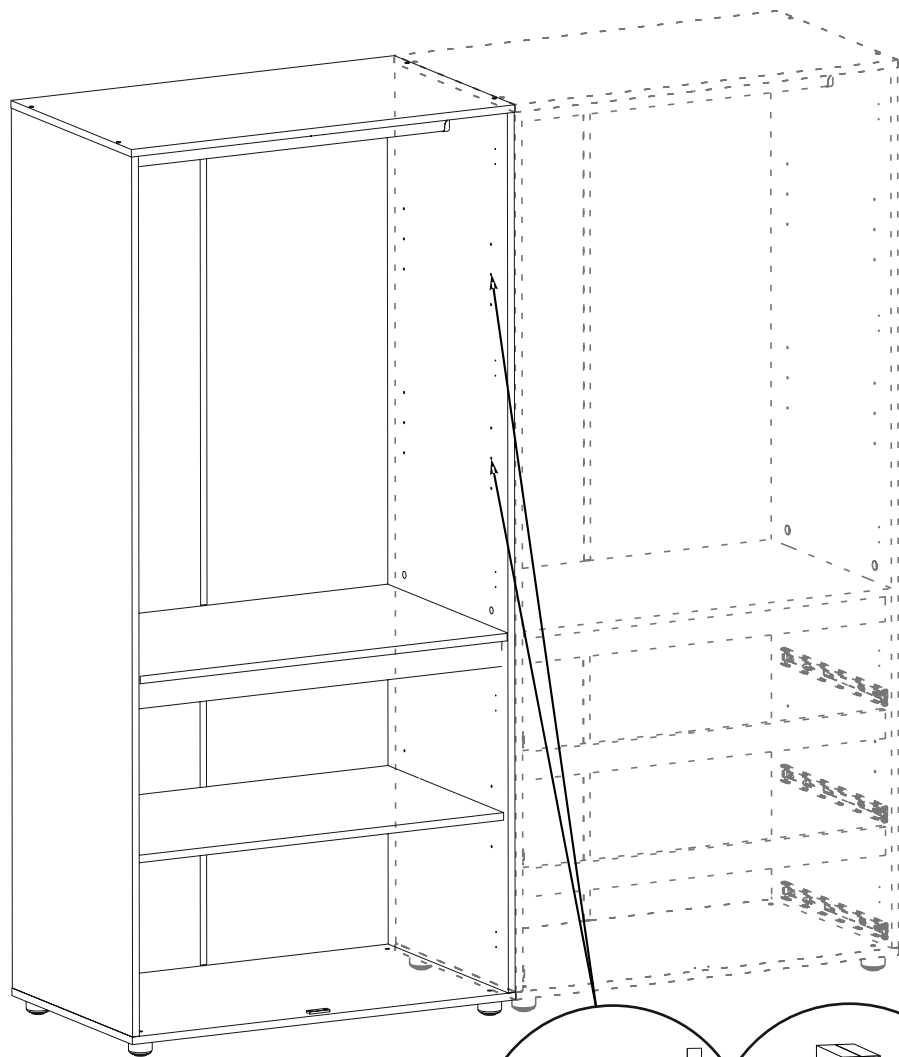

Wardrob-28
Шафа-28

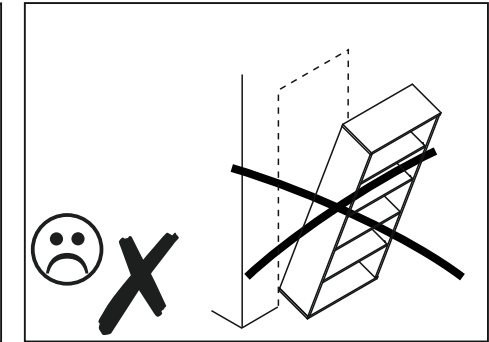
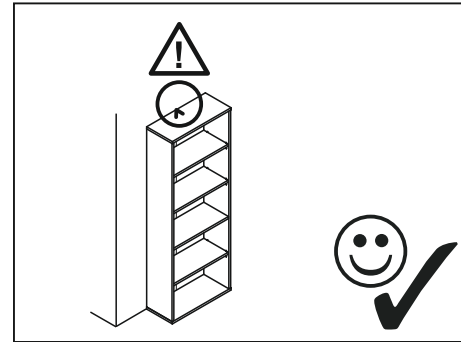
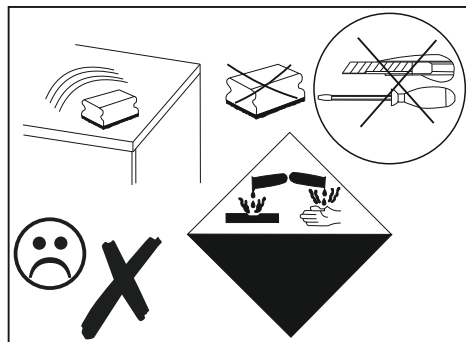
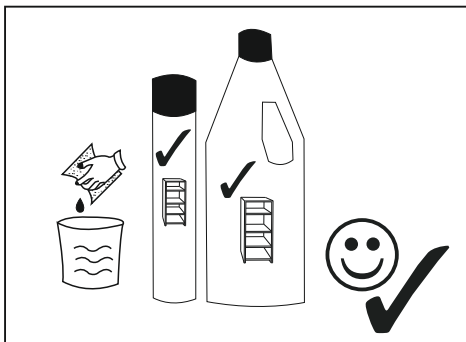
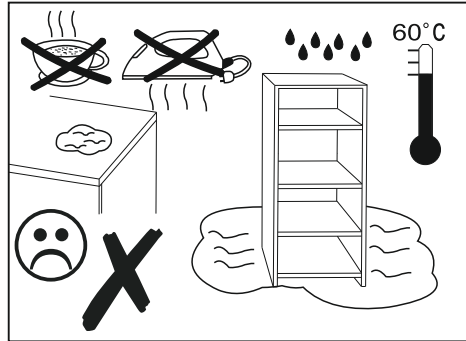
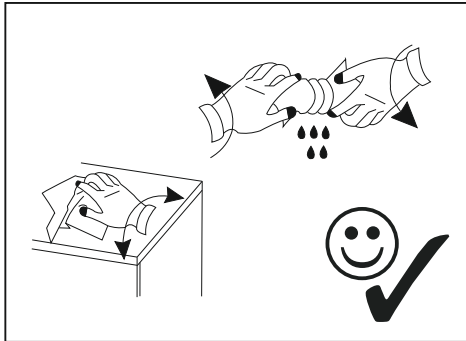
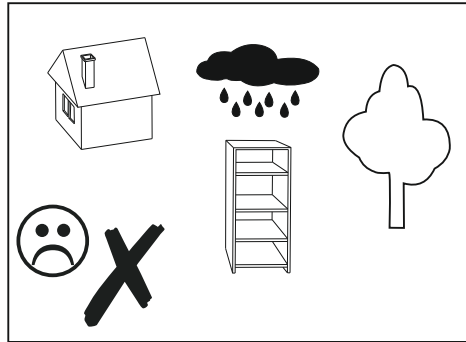
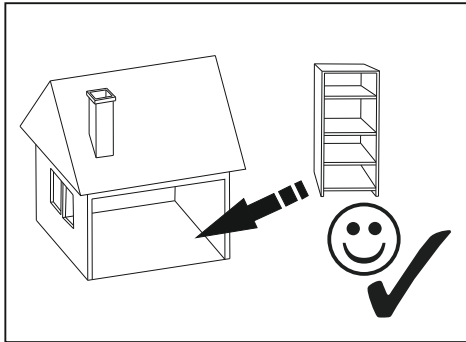

Important information
Read carefully.
Keep this information for further reference.

(GB) WARNING

Serious or fatal crushing injuries can occur from furniture tip-over. To prevent this furniture from tipping over it must be permanently fixed to the wall.

Fixing devices for the wall are not included since different wall materials require different types of fixing devices. Use fixing devices suitable for the walls in your home. For advice on suitable fixing systems, contact your local specialized dealer.

Wichtige Information
Sorgfältig lesen
Diese Information aufbewahren

(DE) ACHTUNG

Wenn Möbelstücke umkippen, können ernste oder lebensgefährliche Verletzungen durch Einklemmen die Folge sein. Um zu verhindern, dass das Möbelstück umkippt, muss es fest an der Wand verankert werden.

Beschläge für die Wandbefestigung sind nicht beigegeben, da sie von der jeweiligen Wandbeschaffenheit abhängig sind. Befestigungsbeschläge benutzen, die für die heimischen Wände geeignet sind. Bei diesbezüglichen Fragen den örtlichen Fachhandel zu Rate ziehen.

Ważne informacje
Przeczytaj uważnie.
Zachowaj ulotkę na przyszłość.

(PL) UWAGA

Przewrócenie sięmebli może doprowadzić do poważnych obrażeńlubśmierci. Aby zapobiec przewróceniu sięmebla, należy na stałe przymocowaćgo dościany.

W zestawie nie znajdujəsięzaśnideśruby mocujące, ponieważróżne rodzajescięcian wymagająróżnych typówśrub. Użyjśrub odpowiednich dościan w Twoim domu. W przypadku wątpilności, jakich śrub użyć, skontaktuj sięz najbliższym specjalistycznym sklepem.

Information importante
Aire attentivement.
Conserver ces informations pour un usage ultérieur.

(FR) AVERTISSEMENT

Risque de blessure grave en cas de chute du meuble. Pour éviter que le meuble ne bascule, il faut le fixer au mur de façon permanente.

Les fixations ne sont pas incluses car leur choix dépend du matériau du mur sur lequel est fixé le meuble. Utilisez des fixations adaptées au matériau du mur. Pour obtenir des conseils sur les fixations à utiliser, adressez-vous à un revendeur spécialisé.

Informații importante
Citește cu atenție.
Păstreazăaceste informații pentru referințe ulterioare.

(RO) ATENȚIE

Pot surveni răni grave dacăte împiedici de obiectele de mobilier. Pentru prevenirea rănilor, fixeazămobila pe perete.

Accesoriiile de fixare pentru perete nu sunt incluse deoarece materialele diferite din care sunt făcuți pereții au nevoie de accesorii diferite de fixare. Folosește accesoriiile de fixare potrivite pentru pereții camerei tale. Contacteazăun specialist dacănuștii care sunt accesoriiile potrivite pereților casei tale.

Важлива інформація
Прочитайте уважно
Збережіть цю інструкцію

(UA) УВАГА

Падіння незакріплених меблів може спричинити серйозне або смертельне травмування людини. Щоб запобігти перекиданню цих меблів, їх слід міцно прикріпити до стіни

Кріплення до стіни не додаються, оскільки різні матеріали потребують різних кріплень. Використовуйте кріпильні пристрої, які пасують матеріалу Ваших стін. За порадою щодо належних систем кріплення звертайтеся у місцеву спеціалізовану крамницю.