

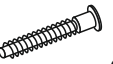

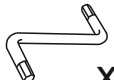





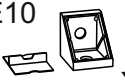
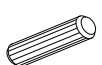
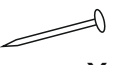
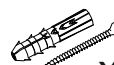

B1  $\phi 6,4 \times 50 \text{mm}$ x8	R  x1	B  x8
L9  x4	E10  x2	A1  $\phi 8 \times 30$ x12
Q  x40	E8  x1	E3  $\phi 3.5 \times 16 \text{mm}$ x128
K2  x4	S7  x1	R5  L=556mm x4
C2  84 mm x2	D1  16 mm x4	D  x4

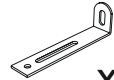
No	a x b	x
1	618X240	1
2	725X240	1
3	556X100	2
4	618X240	1
5	725X240	1
6	590X240	1
7	556X100	1
8	550X298	4
9	520X80	4
10	520X140	8
11	584X218	6

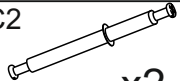
 - L=10mm
 - DVP/ДВП

(ENG) Cabinet for shoes "TO-24"

(UA) Тумба під взуття "ТО-24"

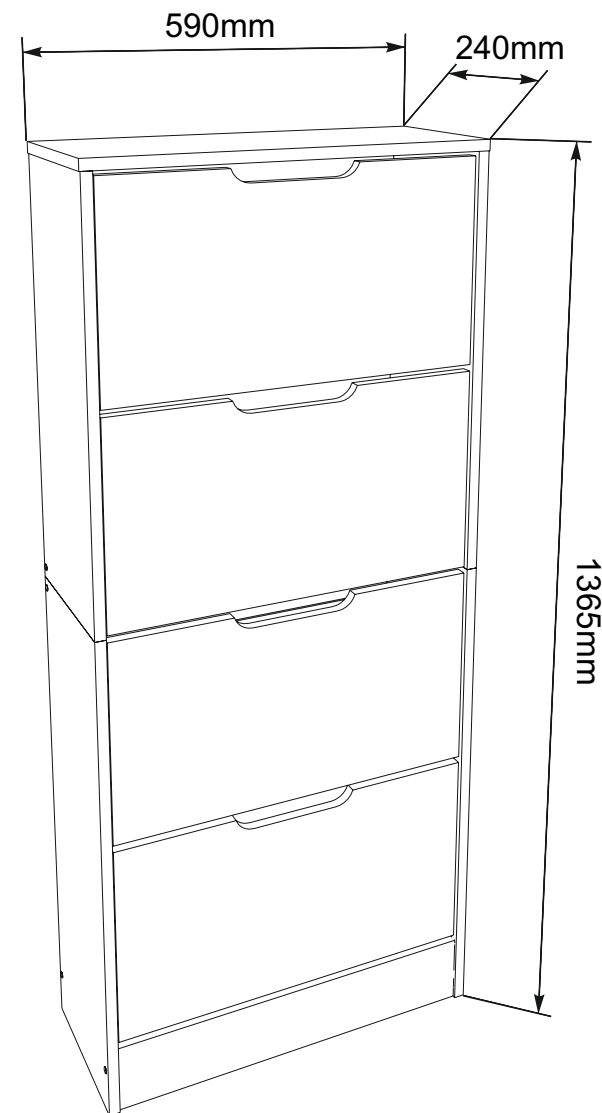

"TO-24"

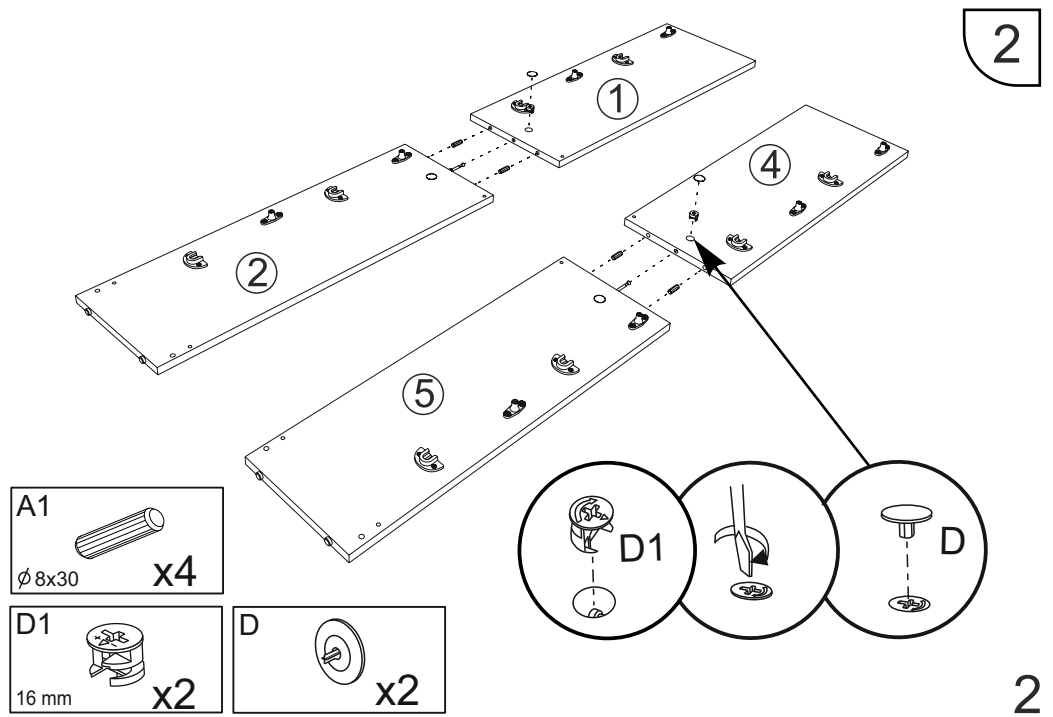
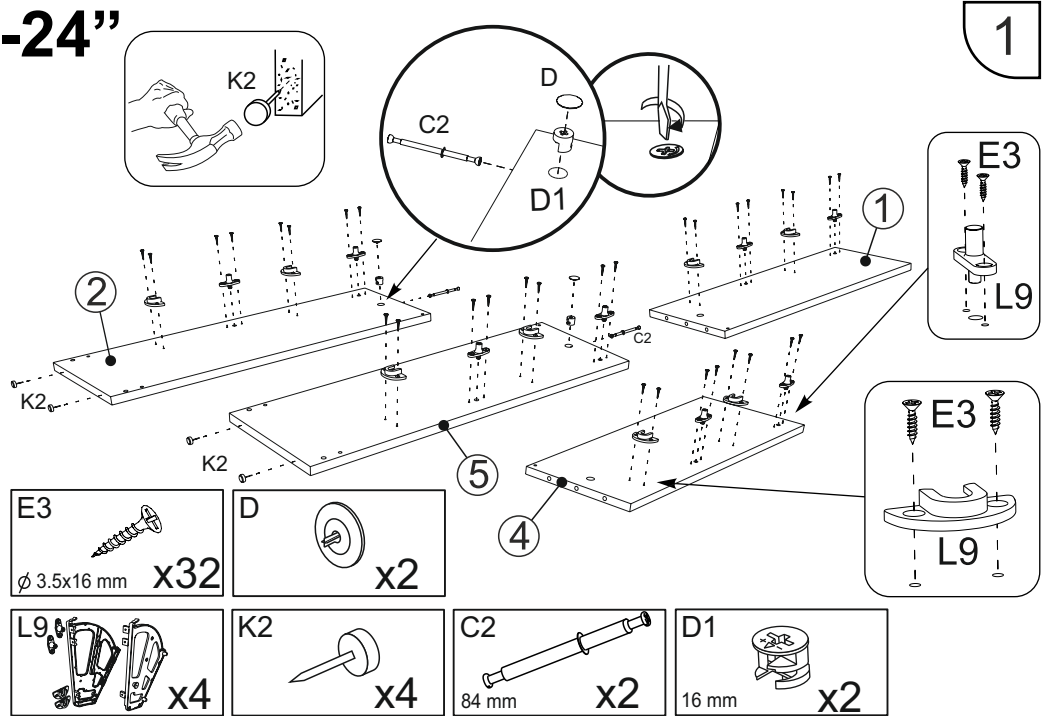
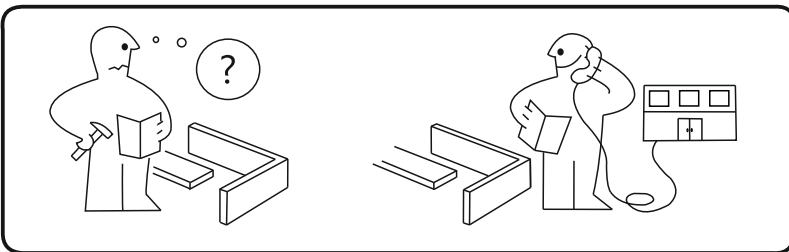
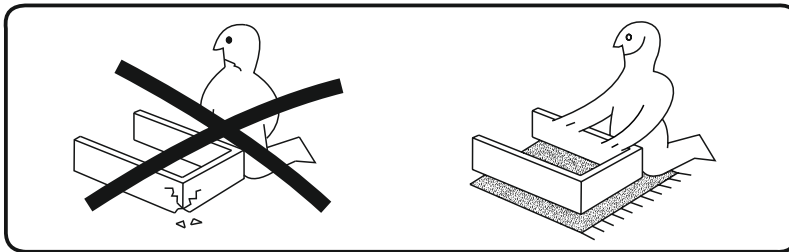
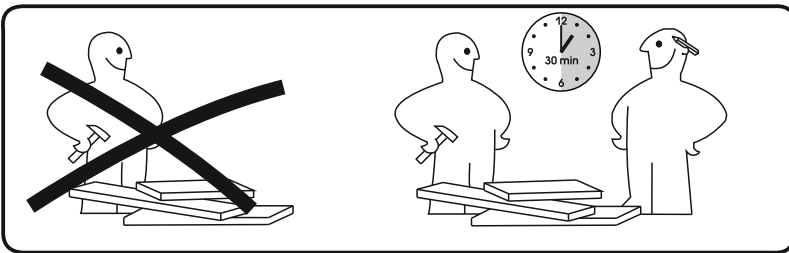
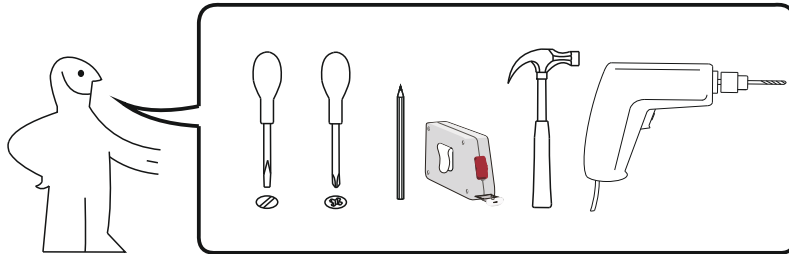
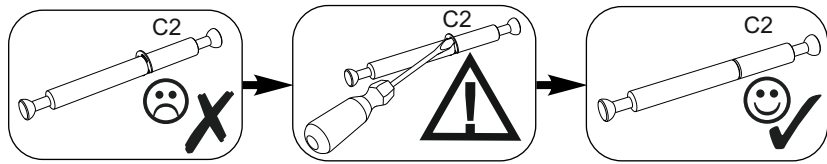

3 "TO-24" x4

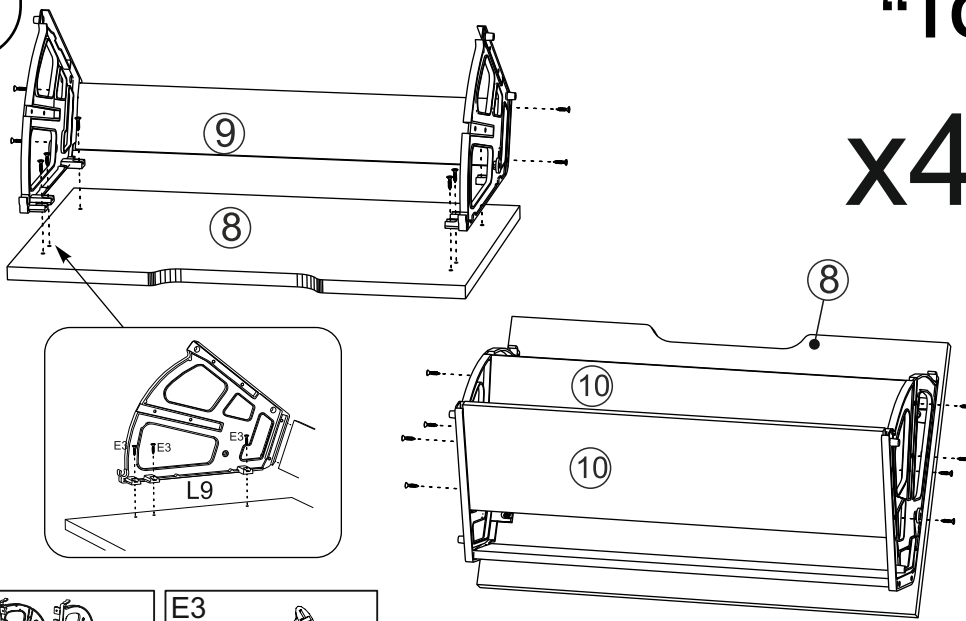

- L9 x4
- E3 ϕ 3.5x16 mm x72

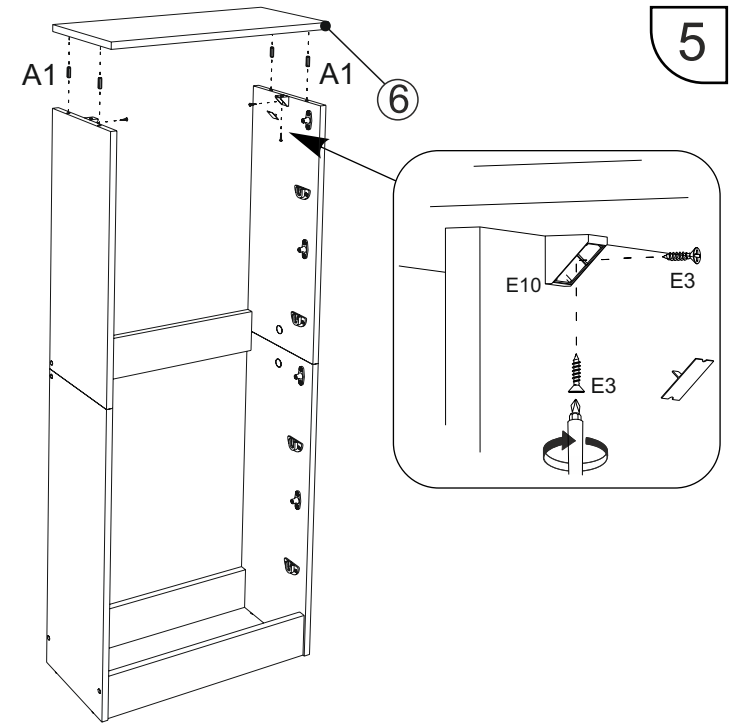

- A1 ϕ 8x30 x4
- E3 ϕ 3.5x16 mm x4
- E10 x2

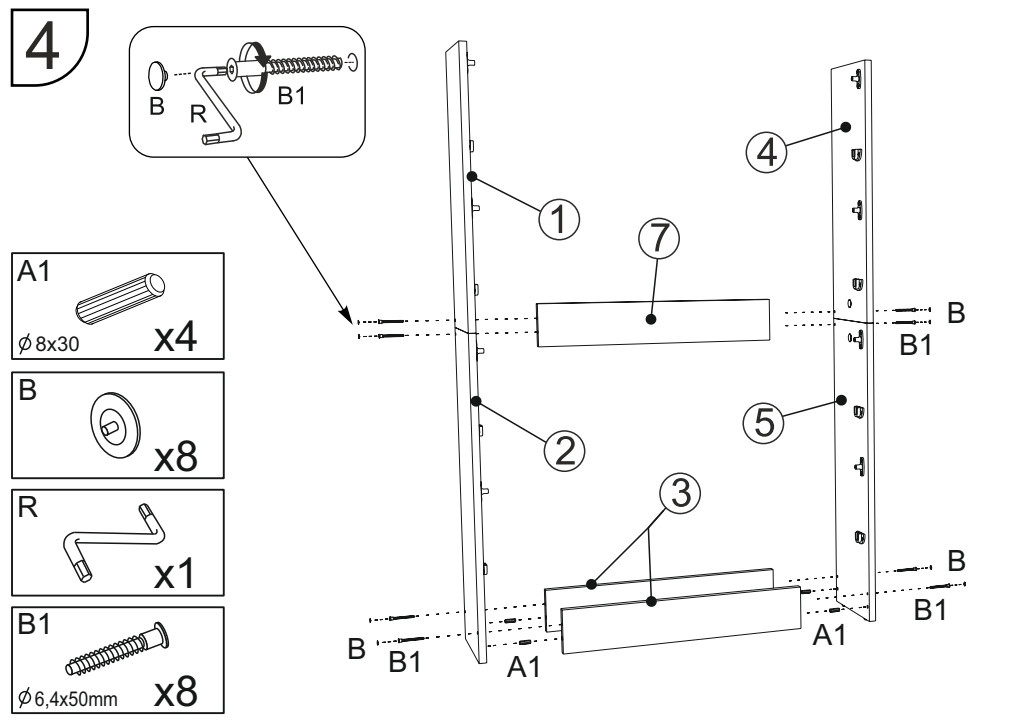

- A1 ϕ 8x30 x4
- B x8
- R x1
- B1 ϕ 6,4x50mm x8

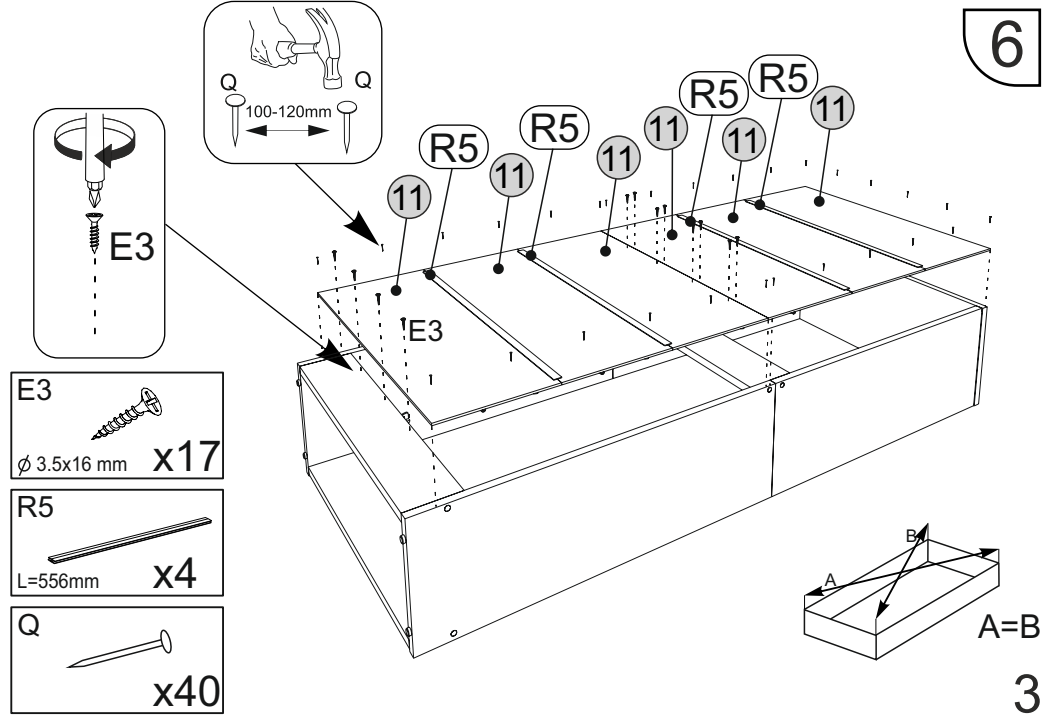

- E3 ϕ 3.5x16 mm x17
- R5 L=556mm x4
- Q x40

7

"TO-24"

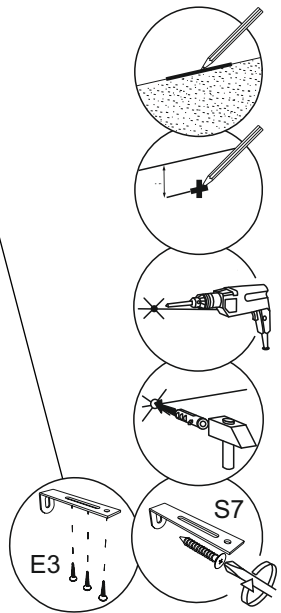
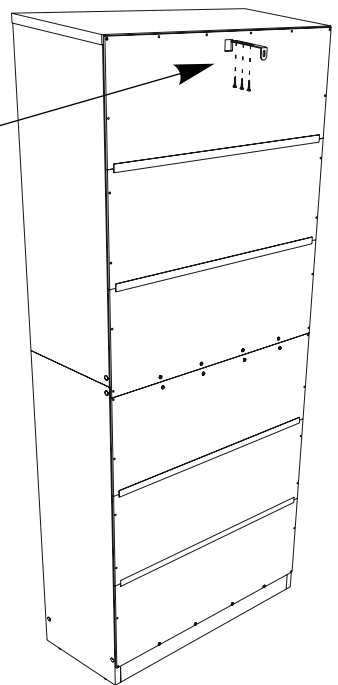
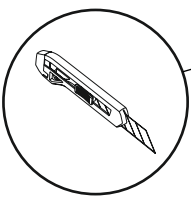

- E3 ϕ 3.5x16 mm x3
- E8 x1
- S7 x1

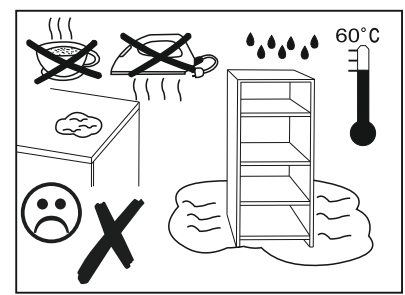
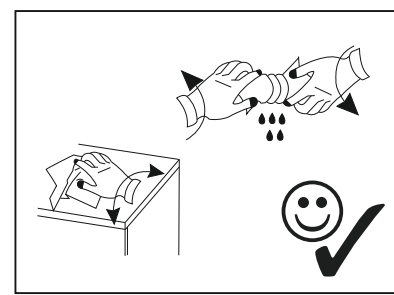
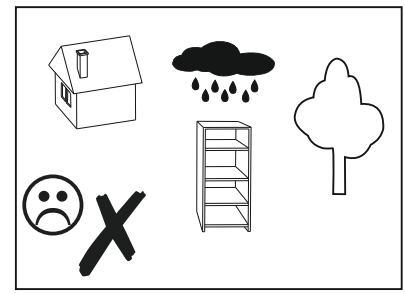
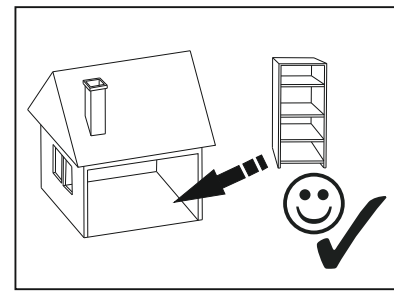

8

